

Multifunction Digital Timer

H5BR

Easy-to-Use Timer with Batch Counting
in 72 x 72 mm DIN Size Unit

- Nine field-selectable output modes accommodate a wide variety of applications
- All parameters set by scroll-through menus accessed from the front panel
- Field-selectable time ranges from 0.001 second to 9999 hours
- High-visibility alphanumeric LCD display has 12 mm high characters and built-in backlight
- Batch counting function records the number of completed cycles
- Contact and solid-state outputs available simultaneously
- Precision control possible to 0.001 second
- Four levels of key protection provided
- Selectable elapsed time (UP) and time remaining (DOWN) display



Ordering Information

■ TIMERS

Timing functions	9 selectable, including ON-delay, repeat cycle, OFF-delay, and one-shot	
Contact type	One SPDT relay and two NPN open collector transistor outputs	
Terminal form	16 terminal screws on rear of case	
Supply voltage	100 to 240 VAC, 50/60 Hz	24 VAC, 50/60 Hz and 12 to 24 VDC
Part number	H5BR-B-AC100-240	H5BR-B-AC24/DC12-24

■ ACCESSORIES

Description	Part number
Soft cover with two mounting clips for front panel protection	Y92A-72F1
Shock prevention terminal cover protects wiring connections	Y92A-72T

■ RANGE AND OPERATION MODE SELECTION

Range selection	Time unit	Maximum setting
- . - - - s	0.001 second	9.999 seconds
- . . - - s	0.01 second	99.99 seconds
- - . - - s	0.1 second	999.9 seconds
- - - - s	1 second	9999 seconds
- - min - - s	1 second	99 minutes 59 seconds
- - . - min	0.1 minute	999.9 minutes
- - - - min	1 minute	9999 minutes
- - hr - - min	1 minute	99 hours 59 minutes
- - . - hr	0.1 hour	999.9 hours
- - - - hr	1 hour	9999 hours

Mode	Operation	Output type
A	ON-delay	Sustained or one-shot*
A-1	Sustained start signal ON-delay	
A-2	Power ON-delay	
A-3	Power ON-delay/non-power resettable	
B	Repeat cycle	Sustained
B-1	Repeat cycle/non-power resettable	
D	OFF-delay	
E	One-shot	
F	Cumulative signal ON-delay	

*One-shot output can be set from 0.1 to 99.9 s.

Specifications

Part number		H5BR-B-AC100-240	H5BR-B-AC24/DC12-24	
Supply voltage		100 to 240 VAC, 50/60 Hz	24 VAC, 50/60 Hz and 12 to 24 VDC (permissible ripple: 20% max.)	
Operating voltage		85% to 110% of rated voltage		
Power consumption	AC	Approximately 8 VA at 50 Hz, 240 VAC		
	DC	Approximately 5 W at 24 VDC		
Inputs	Types available		Start, reset, gate, batch count reset, and key protect	
	Signal, reset, gate, batch count reset	Type	No-voltage input	
		ON impedance	1 kΩ max. (Approx. 2 mA when 0Ω)	
		Residual voltage	2 V max. in ON state	
		OFF impedance	100 kΩ minimum	
		Pulse width	1 ms or 20 ms selectable for reset and signal 20 ms for gate and batch count reset	
	Key protect	Type	No-voltage input	
		ON impedance	1 kΩ max. (Approx. 2 mA when 0Ω)	
		Residual voltage	1 V max. in ON state	
		OFF impedance	100 kΩ minimum	
Response time		1 second		
Control output	Type	Time limit	SPDT relay output or NPN open collector transistor output	
		Instantaneous	—	
	Relay	Max. load	5 A, 250 VAC resistive load (p.f. = 1)	
		Min. load	10 mA, 5 VDC	
	Solid-state	Max. load	100 mA, 30 VDC	
Residual voltage		2 V max., 1 V typical		
Batch output		Transistor output (NPN open collector)		
Repeat accuracy	Power start	±0.01%, ±0.05 second max.		
	Signal start	±0.005%, ±0.03 second max. (rate for set value)		
Setting error		—		
Resetting system		Power reset (A, A-1, A-2, B, D and E modes) External, manual, automatic resets (may be internal depending on A-1, B, B-1, D and E operation modes)		
Resetting time	Power reset	0.5 second minimum (A, A-1, A-2, B, D and E modes)		
Indicators		4-digit LCD alphanumeric display with backlighting 12 mm (0.47 in) H present value, 8 mm (0.31 in) H set value		
Memory function		Retains preset values for 10 years at 20° C (68° F)		
Materials		Plastic case		
Mounting		Panel		
Connections		Screw terminals		
Weight		270 g (9.6 oz)		

SPECIFICATIONS continued

Approvals		UL/ CSA/SEV/CE (EMC)
Operating ambient temperature		-10° to 55°C (14° to 131°F) with no icing
Humidity		35% to 85% RH
Vibration	Mechanical durability	10 to 55 Hz with 0.75 mm (0.03 in) single amplitude in 3 directions
	Malfunction durability	10 to 55 Hz with 0.5 mm (0.02 in) single amplitude in 3 directions
Shock	Mechanical durability	30 G each in three directions
	Malfunction durability	10 G each in three directions
Variation due to voltage change		Included in "Repeat accuracy" specification
Variation due to temperature change		Included in "Repeat accuracy" specification
Insulation resistance		100 MΩ min. at 500 VDC between current-carrying terminal and exposed non-current-carrying metal parts, and between non-continuous contacts.
Dielectric strength		2,000 VAC, 50/60 Hz for 1 minute between current-carrying terminal and exposed non-current-carrying metal parts for 100 to 240 VAC type 1,000 VAC for both 24 VAC and 12 to 24 VDC types
Service life (SPDT relay)	Mechanical	10 million operations minimum
	Electrical	100,000 operations minimum at 5 A, 240 VAC, resistive load (p.f. = 1)

Timing Charts

■ OPERATION MODES

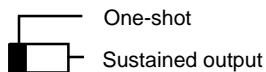
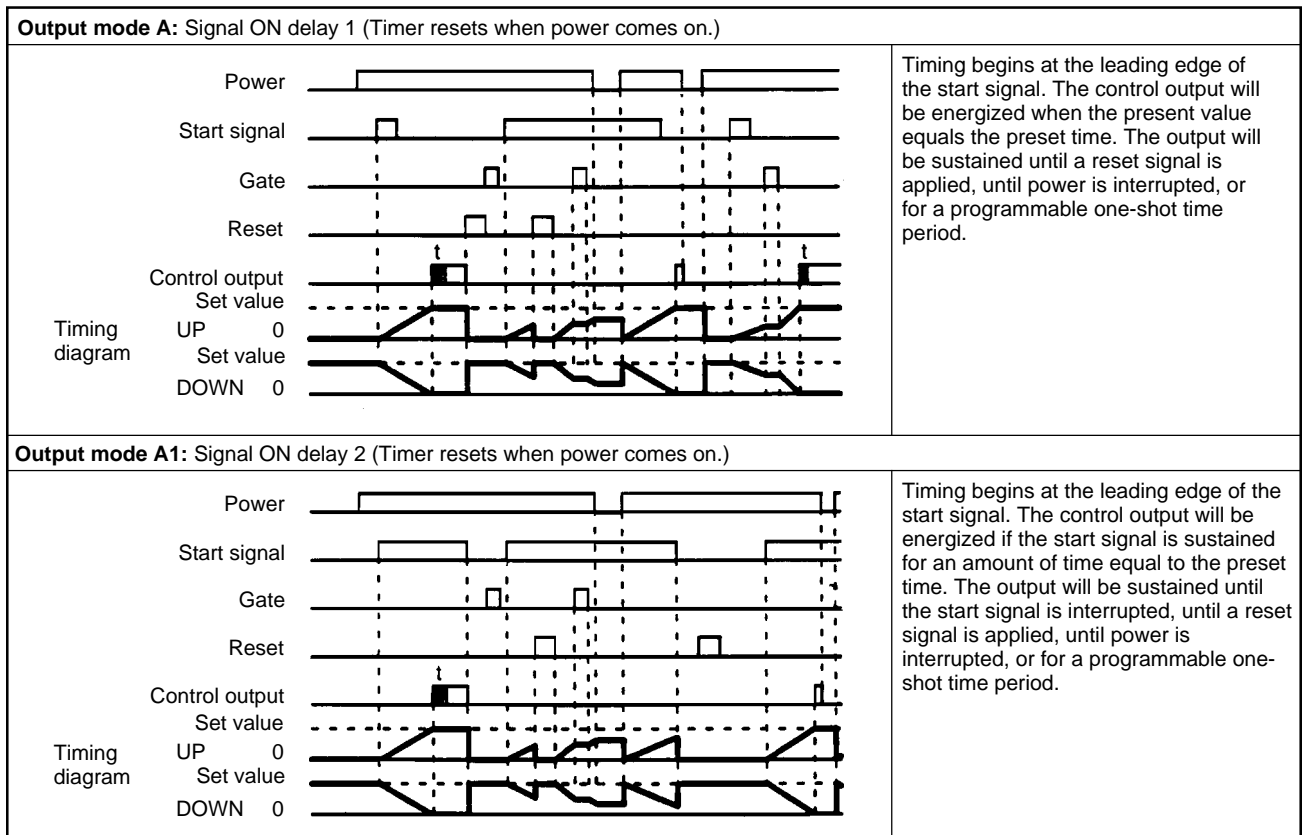

One-shot output can be set from 0.1 s to 99.9 s.

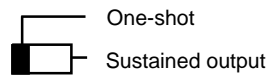
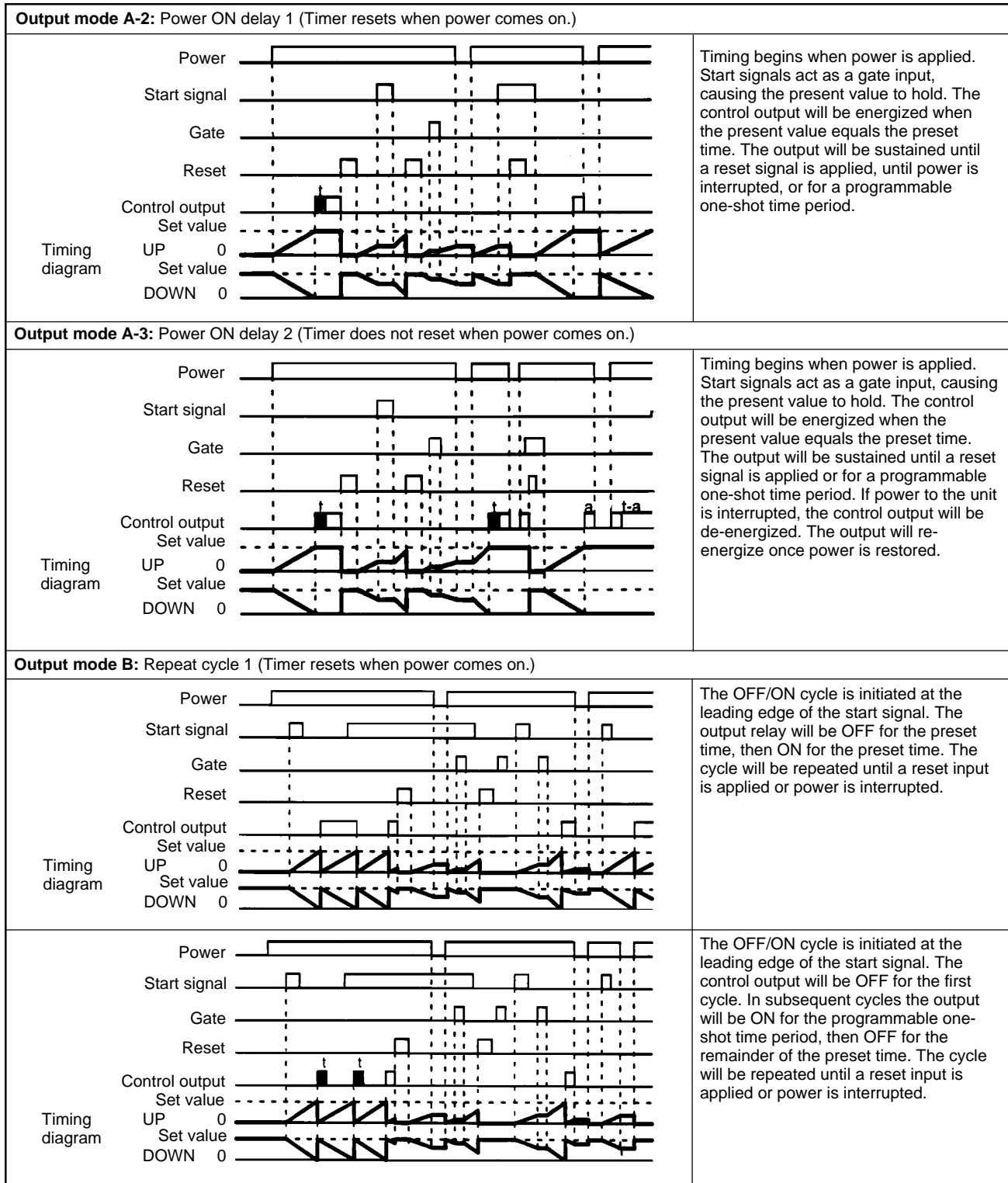

One-shot output can be set from 0.1 s to 99.9 s.
 a = one-shot time before power interruption
 t-a = remaining one-shot time after power interruption

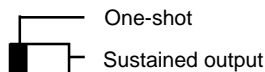
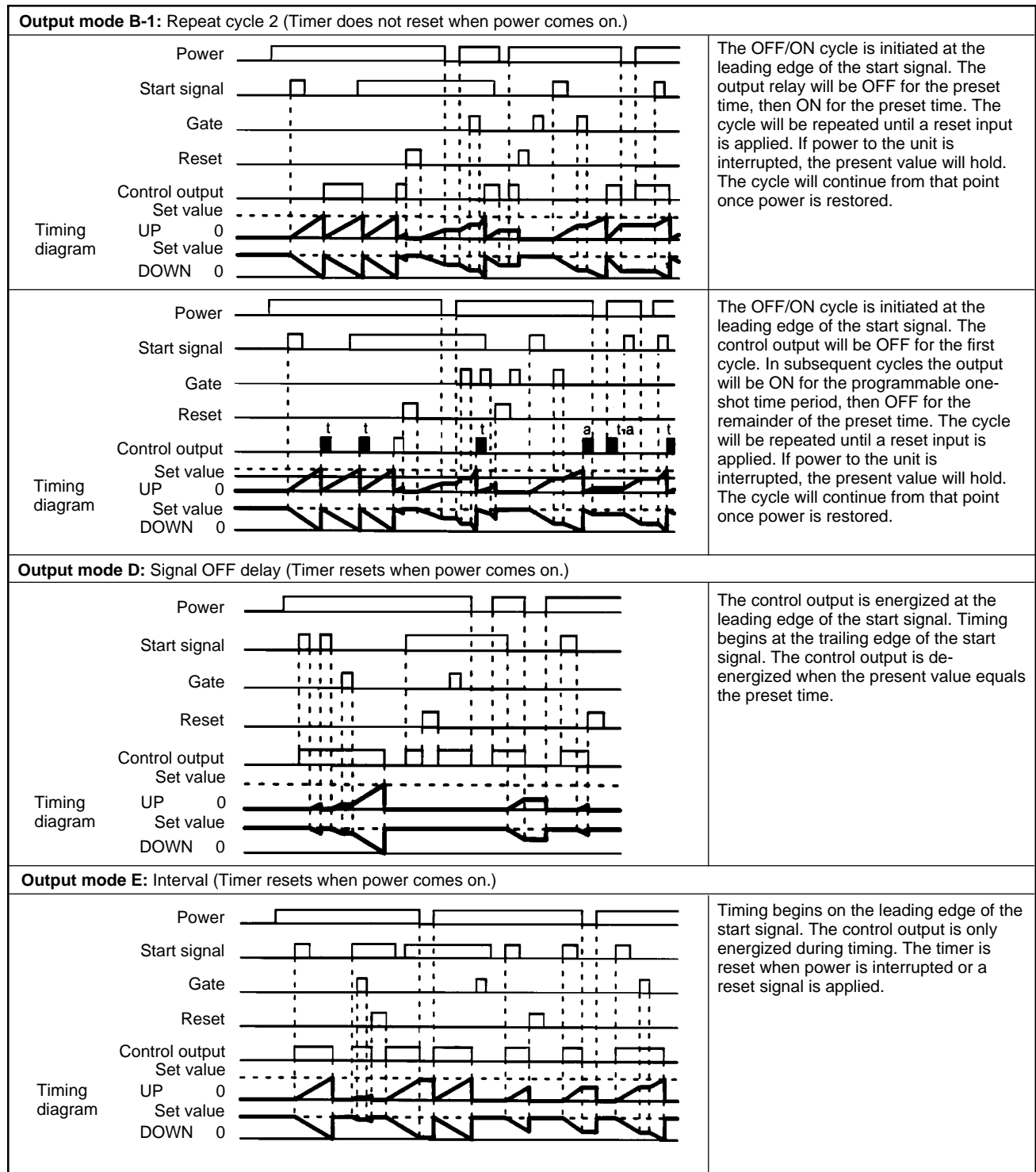

One-shot output can be set from 0.1 s to 99.9 s.

a = one-shot time before power interruption

t-a = remaining one-shot time after power interruption

Output mode F: Cumulative (Timer does not reset when power comes on.)

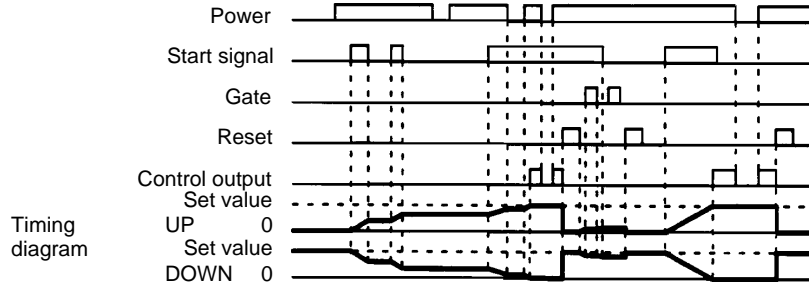

Timing begins on the leading edge of the start signal. The control output is energized when the cumulative elapsed time of the start signal is equal to the preset time. The output is sustained until power is interrupted or a reset signal is applied.

BATCH COUNTER OPERATION

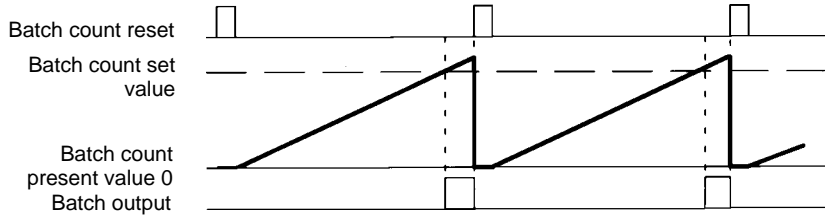

The batch count output holds until reset by the batch count reset. The present value of the batch count advances continuously.

1. The batch count present value remains at 0 while the batch count reset is ON.
2. When the batch count set value is 0, the batch count will proceed, but there will be no output.
3. When the batch count present value exceeds 9999, it returns to 0.
4. The batch count present value and output are not affected by the RESET key or reset input.
5. When power is interrupted and the batch count output is ON, the output will be ON when power returns.
6. When a batch count set value greater than the present value is changed to a set value less than the present value, the output will go ON.
7. If, after the output has gone ON, the set value is changed to a set value that is greater than the present value, the output will remain ON.
8. When utilizing latching outputs in the repeat cycle modes (B and B1), the number of completed timing is double the number of outputs. To control the number of outputs, set the batch count set value at double the desired number of outputs.

Dimensions

Unit: mm (inch)

TIMER

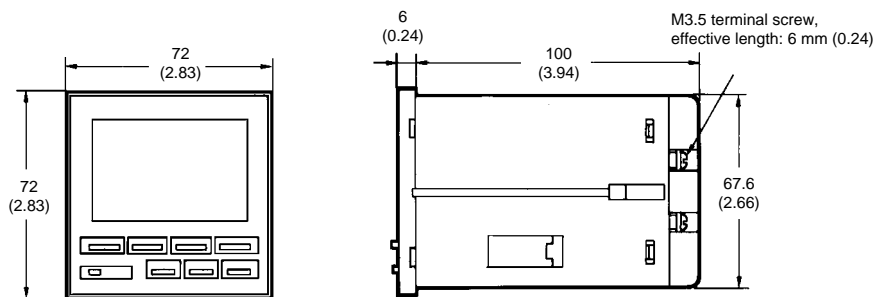
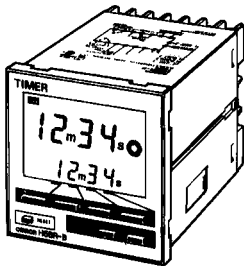

■ PANEL MOUNTING H5BR TIMERS

A pair of panel mounting adapters is included with the timer. The adapters are installed in the slots on the right and left sides of the case, as shown below.

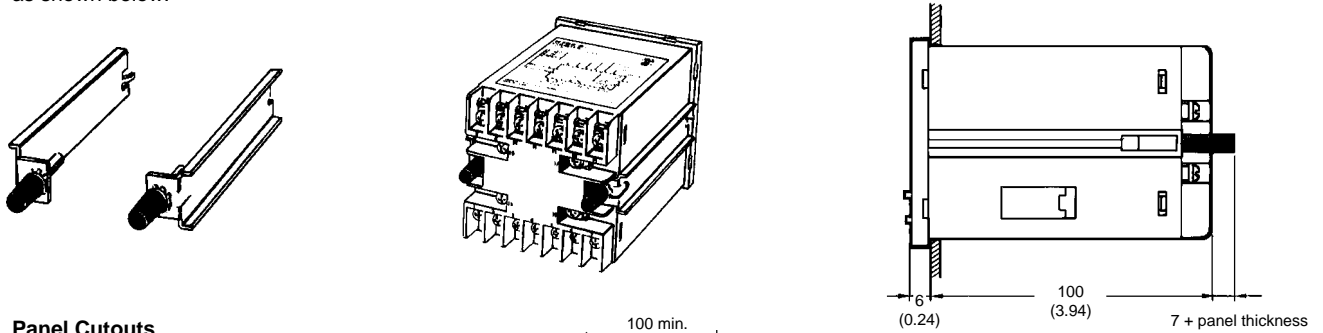

Panel Cutouts

Panel cutouts shown at right conform to DIN 43700.

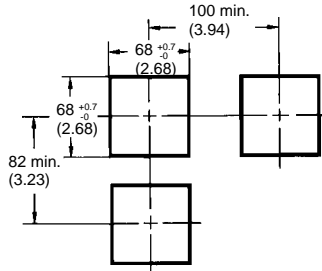

■ ACCESSORIES

Y92A-72F1 Soft plastic cover

Two mounting clips help the soft plastic cover Y92A-72F1 fit snugly over the front of the timer to protect against dirt and water. Timer settings can be changed when the cover is on. The cover is intended for use in areas where unusual service conditions do not exist.

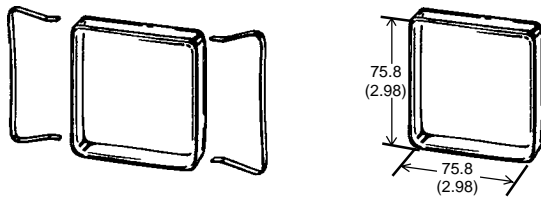

Y92A-72T Terminal cover

The terminal cover protects wiring connections.

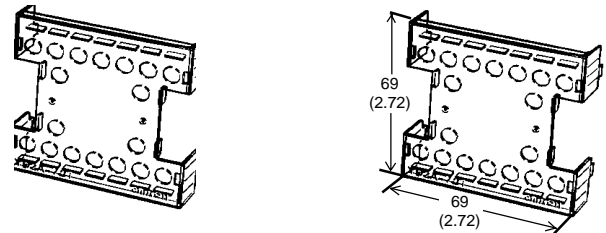

Connections

■ TERMINAL ARRANGEMENT

H5BR-B

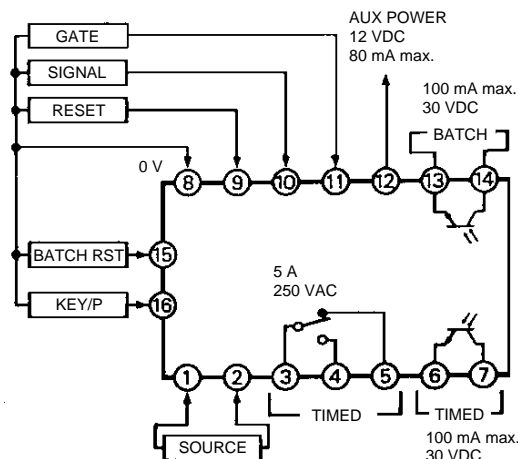

Note: Do not connect unused terminals.

■ INPUTS

The inputs of the H5BR are no-voltage (short circuit or open) inputs.

No-contact Input (NPN Transistor)

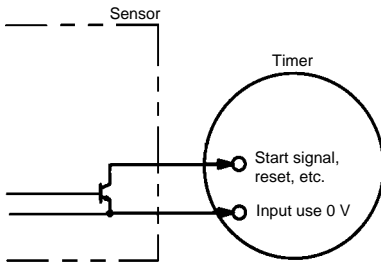

High: transistor ON

Contact Input

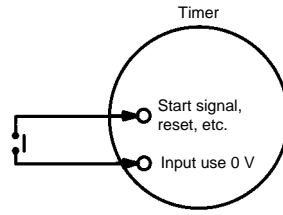

High: contact ON

No-contact Input

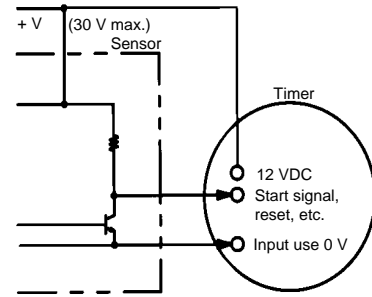

High: transistor ON

No-voltage Input Signal Levels

No-contact input	1. High level Transistor ON Residual voltage: 2 V max. Impedance when ON: 1 kΩ max.
	2. Low level Transistor OFF Impedance when OFF: 100 kΩ min.
Contact input	Use contacts which can adequately switch 2 mA at 5 V.

Terminal Numbers on Power Supply for External Equipment

Voltage supply	DC-	DC+
12 VDC, 80 mA	8	12

Input terminal numbers (no voltage)						Power supply terminals		Output terminal numbers						
Reset	Start	Gate	Batch reset	Key protect	COM	AC (common), DC-	AC (hot), DC+	Contact		Solid-state				
								COM	NO	Timed			Batch	
										NC	COM	Load	COM	Load
9	10	11	15	16	8	1	2	3	4	5	6	7	13	14

Operation

■ NOMENCLATURE

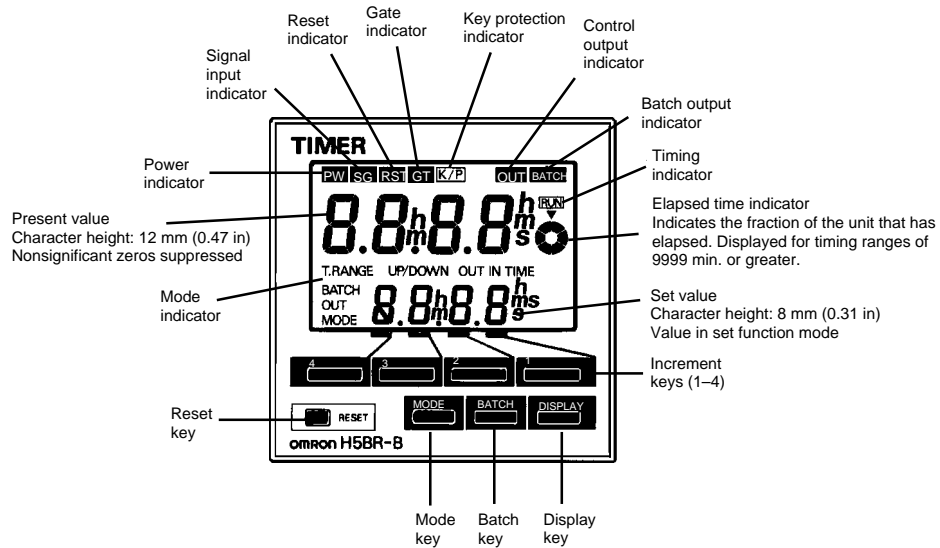

■ KEY OPERATIONS

Key name	Operation
Increment keys (1-4)	Used to change the corresponding digit of the set value. Used to change data in the set mode.
Display key	Switches to the present value display.
Batch key	Switches to the batch display.
Mode key	Switches from run mode to set mode. Changes items in the set mode.
Reset key	Resets timing and outputs.

■ FACTORY SETTINGS

The following table shows the timer settings when it is shipped. Change the settings as necessary to suit the system before operation. Settings and the display receive power from the internal battery and are, therefore, unaffected by external power interruptions. With the initial settings, there will be no output even if the power supply is connected. External inputs and outputs cannot be used without a power supply.

Model	H5BR-B (Standard)
Time range	- - - -s
Present value	0.00 s
Presets	0.00 s
Batch present count	0
Batch preset	0
UP/DOWN mode	UP
Output mode	A: Signal ON-delay (1)
Output time	Hold
Input signal time	20 ms
Key protect level	KP-1

■ INPUT/OUTPUT FUNCTIONS

Inputs	Start signal	Stops timing in A-2 and A-3 (power ON-delay) modes. Starts timing in other modes.
	Reset	Resets present value (to zero in UP mode, to preset in DOWN mode). Control inputs are not accepted while reset input is ON. Reset indicator lit while reset input is ON.
	Gate	Inhibits timer operation.
	Batch count reset	Resets batch count to zero and batch output turns OFF on leading edge. Batch count signals are not accepted while batch count reset is ON.
	Key protect	Makes keys inoperative according to key protect level; four levels available. Key protected indicator lit while key protect input is ON. Effective when protect terminals are shorted. Effective if power supply is turned off.
Outputs	Control output (OUT)	Outputs made according to designated output mode when corresponding preset is reached.
	Batch output	Outputs made when batch count equals the preset number of batches. Batch output remains ON until batch count reset goes ON. When the number of batches is set to zero, batch counting is performed, but batch outputs are not made.

■ BATCH COUNTER APPLICATION

Counting the Number of Bottles Filled

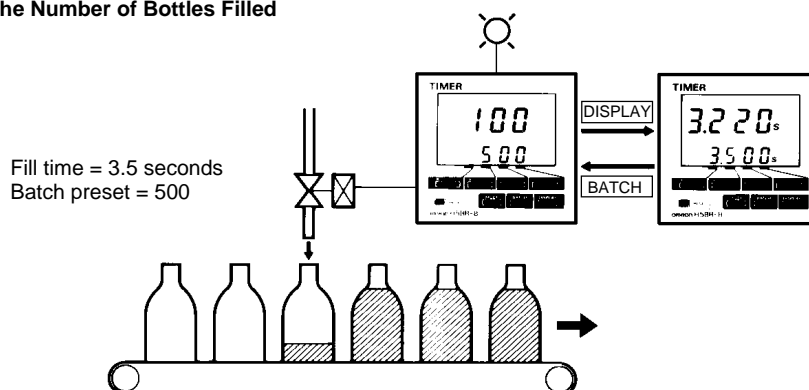

OPERATIONAL OVERVIEW

Refer to the Setting Item Table below for details on the operation of specific modes.

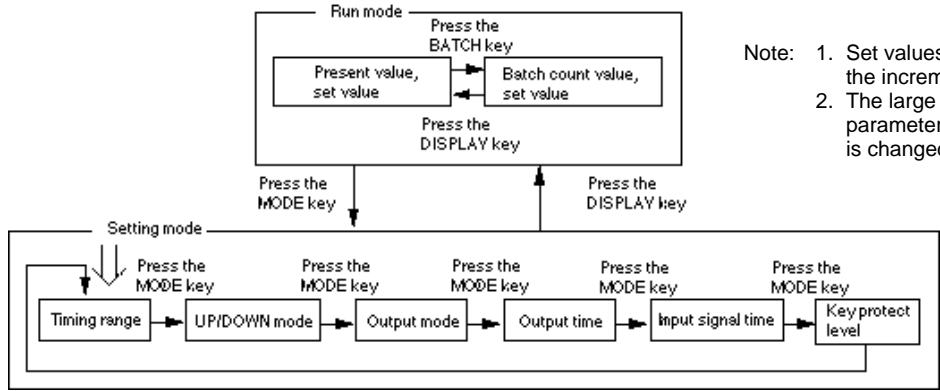

- Note: 1. Set values are changed using the increment keys (1 to 4).
- 2. The large arrow indicates the parameter displayed first when the mode is changed with the MODE or DISPLAY key.

SETTING ITEM TABLE

Mode	Setting item	Description	Setting procedure
Run mode	Set value	Compared to the present value. Determines the timing of the control output according to the output mode.	Sequence when changing a digit using the increment keys (1 to 4).
	Batch count set value	Turns ON the batch output when the preset number of cycles have been completed.	Sequence when changing a digit using the increment keys (1 to 4).
Setting mode	Time range	Determines the timing range.	Change the timing range with the increment keys (1 to 4).
	UP/DOWN mode	Selects the display that shows elapsed time (UP) or time remaining (DOWN).	Select UP/DOWN with the increment keys (1 to 4). (UP) ↔ (DOWN)
	Output mode	Determines the control output type. (Refer to the Operation Modes Timing Charts on pages 18 to 21.)	Sequence when changing the mode using the increment keys (1 to 4).
	Output time	Determines the duration of the control output. Will be displayed when the output mode is A, A-1, A-2, A-3, B, or B-1. Will not be displayed in output modes D, E, or F.	Use keys 1 to 3 to change the value. Key 1 adjusts the first digit (0.1 digit). Key 2 adjusts the second digit (1 digit). Key 3 adjusts the third digit (10 digit). Key 4 selects either hold output or one-shot output. HoLd ↔ 0.0s
	Input signal time	Changes the duration of the control and reset input signals.	Change the duration with increment keys (1 to 4). (1 ms) 1 ↔ 20 (20 ms)
	Key protect level	Locks certain keys to prevent accidental operation. The key protection level, kP-1 to kP-4, determines which keys are locked when the key protection input is ON. The locked keys are crossed out in the diagram at right.	Sequence when changing the key protect level using the increment keys (1 to 4). <kP-1> <kP-2> <kP-3> <kP-4>

- Note: 1. Changes made in setting mode become effective when run mode is entered.
- 2. The time range setting appears first when setting mode is entered.

■ EXAMPLES

Run Mode

Changing the Set Value

To change the set value from 3 hr 5 min to 4 hr 5 min, press the 3 key so that the number 4 appears in the hour's place.

- Pressing keys 1 through 4 increments the corresponding column by 1.
- The columns can be changed in any order, but the output will be turned ON if the set value is less than the present value.
- Nonsignificant zeros are suppressed on the set value display.

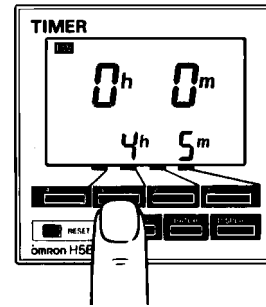

Note: Read *Changing Set Values* in the *Precautions* section before changing the timer set value during operation.

Changing the Batch Count Set Value

1. Press the BATCH key to switch from the present value display to the batch count display.

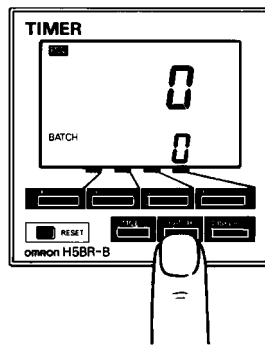

2. Change the set value when the timer is set to the batch count display.

- Nonsignificant zeros are normally suppressed on the batch count set value display.
- Press the DISPLAY key to switch back from the batch count display to the present value display.

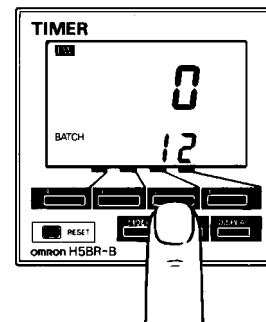

Setting Mode

Changing Settings in the Set Mode

- Press the MODE key to switch from run mode to set mode.
 - The timer will continue operation according to existing settings when switched from run mode to set mode during operation.
 - The MODE key will be locked if the key protection function is enabled.
 - Settings changed in the set mode do not take effect until run mode is entered. Because the operating conditions will change once this occurs, always use the RESET key or a reset input to reset operation.

2. Press the MODE key to scroll successively through the items that can be set.

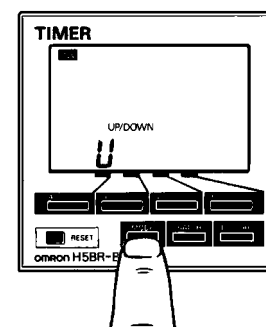
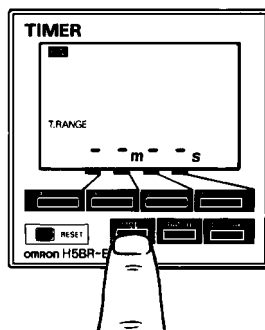

- 3. To change the selected item,
 - Press the MODE key until the desired item appears.

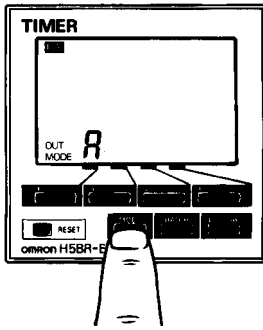

- Change the item setting by pressing keys 1 through 4. (Press the DISPLAY key to switch back from set mode to run mode.)

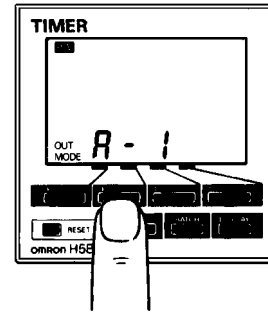

Precautions

EXTERNAL POWER SUPPLY

- The capacity of the external power supply is 80 mA at 12 VDC. When using a 24 VAC/12 to 24 VDC power supply, reduce the load with the power supply voltage, as shown in the following diagram (DC power supplies only).

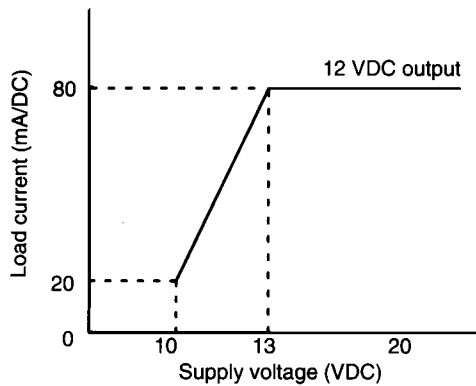

POWER SUPPLIES

- If power is interrupted for less than 10 ms, operation will continue normally. If power is interrupted for 10 to 500 ms, operation will be inconsistent, and timing may stop or reset, depending on the mode.
- Connect the power supply voltage through a relay or switch in such a way that the voltage reaches a fixed value immediately.
- Depending on switching frequency, current surges may degrade relay contacts; relays with a capacity greater than 10 A are recommended.

- Be sure that the capacity of the external power supply is adequate, because the power supply may not provide a surge current sufficient to start the timer due to the switching regulator contained in the timer's internal circuitry.

INPUT AND OUTPUT

- Do not use external sources to increase the voltage of input signals (control signal, reset, gate, and key protection).
- Be sure that the load of the control output (contact, transistor) is less than the maximum values indicated in the specifications. If the output load exceeds the recommended value, the life span of the contact output type will be shortened dramatically, and the transistor of the transistor output type will be damaged.
- The transistor output is opto-isolated from the internal circuitry, so either NPN or PNP transistors can be used.

SELF-DIAGNOSTIC FUNCTION

- The following displays will appear if an error occurs. The present value and output enter the same status as after pressing the RESET key.

Display	Error	Output status	Correction	Set
E1	CPU	OFF	Press RESET key	No change
E2	Memory		(batch count to 0)	Set at the factory

■ CHANGING SET VALUES

- The timer set value can be changed while the timer is operating, so a high value can be set temporarily to inactivate the timer, or a low value can be set to activate the timer more quickly. If the set value is changed accidentally during operation, the timed output might be activated. Therefore, turn the key protection input ON unless the set value is being changed.
- To avoid changing the output when changing the set value, it is recommended to begin changing the set value by entering a large number in the higher digit.

■ OPERATING ENVIRONMENT

- When using the timer in an area with much electrical noise, separate the timer, wiring, and the equipment which generates the input signals as far as possible from the noise sources. It is also recommended to shield the input signal wiring to prevent electrical interference.
- Organic solvents (such as paint thinner), as well as very acidic or basic solutions, might damage the outer casing of the timer.

■ OTHER

- When the timer is installed in a control box and tests are conducted which may damage the timer's internal circuitry (for example, a test measuring the maximum voltage difference between the control circuit and metal components), remove the timer from the control box or short circuit the terminals.

CAUTION

This product contains a lithium battery. Lithium batteries explode if incinerated. Dispose of the digital timer as a non-combustible item.

NOTE: ALL DIMENSIONS ARE IN MILLIMETERS. To convert millimeters into inches, divide by 25.4.

OMRON

Omron Europe B.V. EMA-ISD, tel:+31 23 5681390, fax:+31 23 5681397, <http://www.eu.omron.com/ema>