

OMRON

E5AN

E5EN

E5CN

E5GN

Communications Functions

User's Manual

Cat. No. H102-E1-04

Preface

The E5AN/EN/CN/GN supports serial communications specifications, CompoWay/F and Sysway.

This User's Manual describes the communications functions of the E5AN/EN/CN/GN. Before using your E5AN/EN/CN/GN thoroughly read and understand this manual in order to ensure correct use.

Also, store this manual in a safe place so that it can be retrieved whenever necessary.

© OMRON, 1999

All rights reserved. No part of this publication may be reproduced, stored in a retrieval system or transmitted, in any form, or by any means, mechanical, electronic, photocopying, recording, or otherwise, without the prior written permission of OMRON.

No patent liability is assumed with respect to the use of the information contained herein. Moreover, because OMRON is constantly striving to improve its high-quality products, the information contained in this manual is subject to change without notice. Every precaution has been taken in the preparation of this manual. Nevertheless, OMRON assumes no responsibility for errors or omissions. Neither is any liability assumed for damages resulting from the use of the information contained in this publication.

PRECAUTIONS

When the product is used under the circumstances or environments described in this manual always adhere to the limitations of the rating and functions. Also, for safety, take countermeasures such as fitting fail-safe installations.

DO NOT USE:

- In circumstances or environments that have not been described in this manual.
- For control in nuclear power, railway, aircraft, vehicle, incinerator, medical, entertainment, or safety applications
- Where death or serious property damage may occur, or where extensive safety precautions are required.

SAFETY PRECAUTIONS

■ Safety Signal Words

This manual uses the following signal words to mark safety precautions for the E5AN/EN/CN/GN. These precautions provide important information for the safe application of the product. You must be sure to follow the instructions provided in all safety precautions.

 WARNING	Indicates information that, if not heeded, could possibly result in loss of life or serious injury.
--	---

 CAUTION	Indicates information that, if not heeded, could result in relatively serious or minor injury, damage to the product, or faulty operation.
--	--

■ Safety Precautions

 CAUTION
<p>● Electric Shock Warning</p> <p>Do not touch the terminals while the power is ON. Doing so may cause an electric shock.</p>
<p>Do not allow metal fragments or lead wire scraps to fall inside this product. These may cause electric shock, fire or malfunction.</p>
<p>Never disassemble, repair or modify the product. Doing so may cause electric shock, fire or malfunction.</p>
<p>The life expectancy of the output relays varies greatly with the switching capacity and other switching conditions. Always use the output relays within their rated load and electrical life expectancy. If an output relay is used beyond its life expectancy, its contacts may become fused or burned.</p>
<p>Do not operate this product in flammable and explosive gas atmospheres.</p>
<p>Use this product within the rated load. Not doing so may cause damage or fire.</p>
<p>Use this product within the rated supply voltage. Not doing so may cause damage or fire.</p>
<p>Tighten the terminal screws properly. Loose screws may cause malfunction. Tighten to a torque of :</p> <p>E5AN : 0.74 to 0.90 N·m E5EN : 0.74 to 0.90 N·m E5CN : 0.74 to 0.90 N·m E5GN : Terminals 1 to 6 : 0.23 to 0.25 N·m Terminals 7 to 9 : 0.12 to 0.14 N·m</p>
<p>Set all settings according to the control target of the product. If the settings are not appropriate for the control target, the product may operate in an unexpected manner, resulting in damage to the product or resulting in accidents.</p>
<p>To maintain safety in the event of a product malfunction, always take appropriate safety measures, such as installing an alarm on a separate line to prevent excessive temperature rise. If a malfunction prevents proper control, a major accident may result.</p>

NOTICE

Be sure to observe these precautions to ensure safe use.

- (1) Do not wire unused terminals.
- (2) Be sure to wire properly with correct polarity of terminals.
- (3) To reduce induction noise, separate the high-voltage or large-current power lines from other lines, and avoid parallel or common wiring with the power lines when you are wiring to the terminals. We recommend using separating pipes, ducts, or shielded lines.
- (4) Do not use this product in the following places:
 - Places subject to dust or corrosive gases (in particular, sulfide gas and ammonia gas)
 - Places subject to high humidity, condensation or freezing
 - Places subject to direct sunlight
 - Places subject to vibration and large shocks
 - Places subject to splashing liquid or oily atmosphere
 - Places directly subject to heat radiated from heating equipment
 - Places subject to intense temperature changes
- (5) To allow heat to escape, do not block the area around the product. (Ensure enough space is left for the heat to escape.)
Do not block the ventilation holes on the case.
- (6) When you draw out or draw in the internal mechanism from the housing (E5AN/EN/CN) or draw out the terminals (E5GN), never touch electrical components inside or subject the internal mechanism or terminals to shock.
- (7) Cleaning: Do not use paint thinner or the equivalent. Use standard grade alcohol to clean the product.
- (8) On the E5AN/EN/CN, use specified size (M3.5, width 7.2 mm or less) crimped terminals for wiring. On the E5GN, use AWG24 to AWG14 leads for terminal Nos.1 to 6 (with lead cover peel back allowance of 5 or 6 mm) and AWG28 to AWG22 leads for terminal Nos.7 to 9 (with lead cover peel back allowance of 5 or 6 mm).
- (9) Allow as much space as possible between the E5AN/EN/CN/GN and devices that generate powerful high-frequency noise (e.g. high-frequency welders, high-frequency sewing machines) or surges.
- (10) When executing self-tuning, turn the load (e.g. heater) ON simultaneously with the main unit. If you turn the main unit ON before turning the load ON, correct self-tuning and optimum control can no longer be obtained.
- (11) Use a 100 to 240 VAC (50/60 Hz), 24 VAC (50/60 Hz) or 24 VDC power supply matched to the power specifications of the E5AN/EN/CN/GN. Also, make sure that rated voltage is attained within two seconds of turning the power ON.
- (12) Attach a surge suppressor or noise filter to peripheral devices that generate noise (in particular, motors, transformers, solenoids, magnetic coils or other equipment that have an inductance component).
- (13) When mounting a noise filter on the power supply, be sure to first check the filter's voltage and current capacity, and then mount the filter as close as possible to the E5AN/EN/CN/GN.
- (14) Use within the following temperature and humidity ranges:
 - Temperature: -10 to 55°C, Humidity: 25 to 85% (with no icing or condensation)If the E5AN/EN/CN/GN is installed inside a control board, the ambient temperature must be kept to under 55°C, including the temperature around the E5AN/EN/CN/GN.
If the E5AN/EN/CN/GN is subjected to heat radiation, use a fan to cool the surface of the E5AN/EN/CN/GN to under 55°C.
- (15) Store within the following temperature and humidity ranges:
 - Temperature: -25 to 65°C, Humidity: 25 to 85% (with no icing or condensation)
- (16) Never place heavy objects on, or apply pressure to the E5AN/EN/CN/GN as it may cause it to deform and deteriorate during use or storage.
- (17) Avoid using the E5AN/EN/CN/GN in places near a radio, television set, or wireless installation. These devices can cause radio disturbances which adversely affect the performance of the E5AN/EN/CN/GN.

Conventions Used in This Manual

■ How This Manual is Organized

Purpose	Title	Description
● Introduction	Chapter 1 ABOUT COMMUNICATIONS METHODS	This chapter briefly describes communications methods and wiring.
● CompoWay/F	Chapter 2 CompoWay/F COMMUNICATIONS PROCEDURES	This chapter describes CompoWay/F format communications.
● Communications Data	Chapter 3 COMMUNICATIONS DATA	This chapter lists CompoWay/F and Sysway communications data.
● Sysway	Chapter 4 Sysway COMMUNICATIONS PROCEDURES	This chapter describes Sysway communications.
● Appendix	APPENDIX	

■ Related Manuals

This User's Manual describes the communications functions of the E5AN/EN/CN/GN. For details on the functions of each of these digital controllers, refer to the respective User's Manuals.

Table of Contents

Preface	I
Precautions	II
Safety Precautions	III
Notice	IV
Conventions Used in This Manual	V

CHAPTER 1 ABOUT COMMUNICATIONS METHODS 1-1

This chapter briefly describes the supported communications methods and how to wire equipment. First-time users should read this chapter without fail to ensure proper installation of the equipment.

1.1 Outline	1-2
Introduction	1-2
Communications specifications	1-2
Transmission procedure	1-3
Interface	1-3
Wiring	1-3
Communications parameters	1-5

CHAPTER 2 COMPOWAY/F COMMUNICATIONS PROCEDURES 2-1

Read this chapter if you are to communicate using the CompoWay/F format.

2.1 Data Format	2-2
Command frame	2-2
BCC calculation example	2-3
Response frame	2-3
Communications data	2-4
Example of end code	2-4
2.2 Structure of Command Text	2-6
PDU structure	2-6
Area definitions	2-6
Type code (variable type)	2-6
Addresses	2-7
Number of elements	2-7
List of services	2-7
2.3 Details of Services	2-8
Read from variable area	2-8
Write to variable area	2-9
Read controller attributes	2-11
Read controller status	2-12
Echoback test	2-13
Operation instructions	2-14
2.4 Response Code List	2-17

CHAPTER 3 COMMUNICATIONS DATA 3-1

This chapter lists the details of each of the communications data in the CompoWay/
F and Sysway communications procedures.

- 3.1 Variable Area (setup range) List 3-2
- 3.2 Status 3-8

**CHAPTER 4 SYSWAY (E5 □J, □X FORMAT)
COMMUNICATIONS PROCEDURES 4-1**

These communications procedures are supported for ensuring compatibility with
existing temperature controller models E5jJ and E5jX.

- 4.1 Data Format 4-2
 - Command frame format 4-2
 - FCS calculation example 4-2
 - Response frame 4-3
 - Communications data 4-3
 - Sysway command lists 4-4
- 4.2 Command Descriptions 4-5
 - Read process value 4-5
 - Write set values 4-6
 - Read set value and MV monitor 4-7
 - Communications writing switching 4-8

APPENDIX A-1

- ASCII List (ANSI X 3.4-1986) A-2

INDEX

CHAPTER 1

ABOUT COMMUNICATIONS METHODS

This chapter briefly describes the supported communications methods and how to wire equipment. First-time users should read this chapter without fail to ensure proper installation of the equipment.

1.1	Outline	1-2
	Introduction	1-2
	Communications specifications	1-2
	Transmission procedure	1-3
	Interface	1-3
	Wiring	1-3
	Communications parameters	1-5

1.1 Outline

■ Introduction

The program for the communications functions are created on the host computer, and the E5AN/EN/CN/GN's parameters are monitored or set from the host computer. Therefore, the description provided here is from the viewpoint of the host computer.

CompoWay/F is OMRON's standard communications format for general serial communications. This format uses a standard frame format as well as the FINS* commands which have proven successful in OMRON's PLCs. Therefore, it can simplify communications between components and the host computer.

* FINS (Factory Interface Network Service)

The FINS protocol provides message communications between controllers in OMRON FA networks.

The E5AN/EN/CN/GN have the following communications functions:

- Reading/writing of parameters
- Operation instructions
- Selection of setup levels

Communications are subject to the following condition:

- Parameters can be written only when the "communications writing" parameter is set to ON (enabled).

■ Communications specifications

Transmission line connection	RS-485 : Multiple point RS-232C : Point to point
Communications method *1	RS-485 (2-wire, half-duplex) RS-232C
Synchronization method	Start-stop synchronization
Baud rate	1200, 2400, 4800, 9600 , 19200 bps
Communication code *2	ASCII
Data bits *2	7 or 8 bits
Stop bits *2	1 or 2 bits
Error detection	Vertical parity (non, even , or odd) FCS (frame check sequence) during Sysway communications BCC (block check character) during CompoWay/F communications
Flow control	None
Interface *1	RS-485/RS-232C
Retry function	None
Communications buffer	40 byte

*1 RS-232C is only available with the E5AN/EN.

*2 Communications speed, data bits, stop bits and vertical parity can each be set independently in the communications setting level. Highlighted characters in the table above indicate defaults.

Transmission procedure

When the host computer transmits a command frame, the E5AN/EN/CN/GN transmits a response frame that corresponds to the command frame. A single response frame is returned for each command frame. The following diagram shows the operation of the command and response frames.

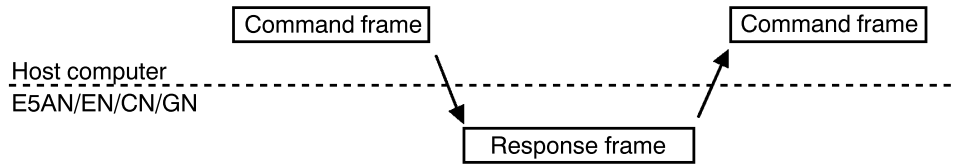

Allow a wait time of at least 2 ms until the next command is sent after the host computer receives a response from the E5AN/EN/CN/GN.

Interface

Communications with the host computer are carried out through a standard RS-485, RS-232C (RS-232C is only available with the E5AN/EN) interface.

Wiring

RS-485

- RS-485 connections can be 1 : 1 or 1 : N. A maximum of 32 Units (including the host computer) can be connected in one-to-N systems.
- The total cable length is 500 m max.
- Use a shielded, twisted-pair cable AWG28 or larger for wiring the E5AN/EN/CN, and AWG24 to AWG14 for wiring the E5GN.

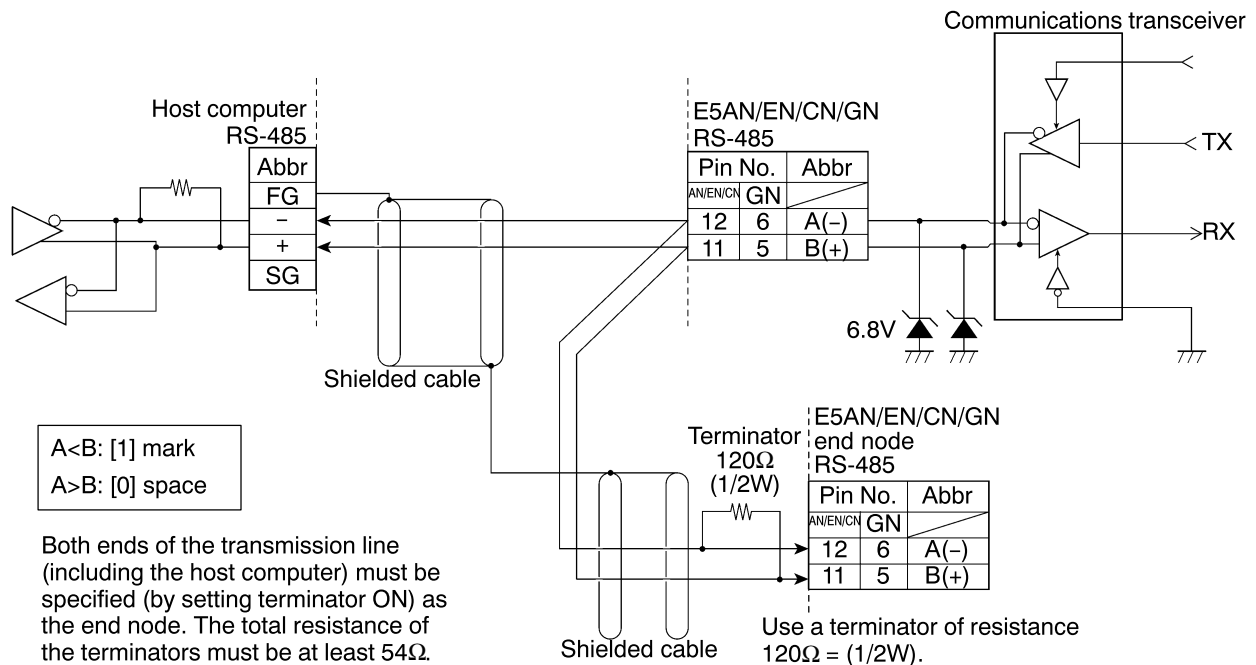

Match the communications specifications of the E5AN/EN/CN/GN and the host computer. If a one-to-N system is being used, be sure that the communications specifications of all devices in the system (except individual unit numbers) are the same.

This section explains how to set the E5AN/EN/CN/GN's communications specifications. For details on the host computer, refer to the User's Manual provided with the host computer.

RS-232C (Applies to the E5AN/EN only.)

- RS-232C connections are 1 : 1.
- The total cable length is 15m max.
- Use a shielded, twisted-pair cable AWG28 or larger.

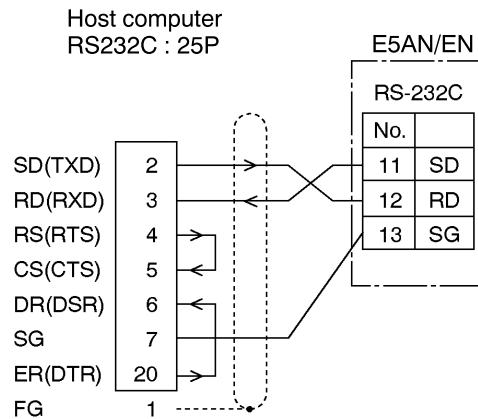

Cable reference diagram

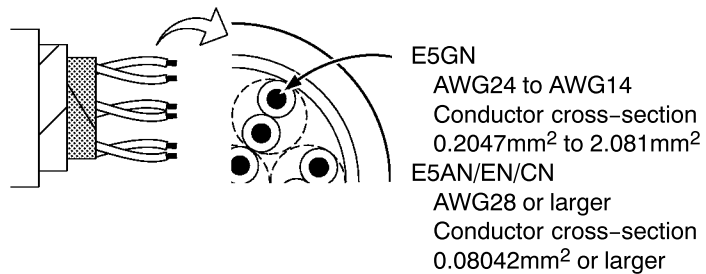

Communications parameters

The E5AN/EN/CN/GN's communications specifications are set in the communications setting level. These parameters are set on the E5AN/EN/CN/GN's front panel.





The following table shows the communications parameters and their setting ranges.

Parameter	Displayed Characters	Setting Range	Set Value
Communications unit No.	U-nō	0 to 99	0, 1 to 99
Baud rate	bPS	1.2 / 2.4 / 4.8 / 9.6 / 19.2 (kbps)	1.2 / 2.4 / 4.8 / 9.6 / 19.2 (kbps)
Communications data length	LEn	7 / 8 (bit)	7 / 8 (bit)
Communications stop bit	Sbct	1 / 2	1 / 2
Communications parity	Prty	None / even / odd	nōnE / EuEn / odd

Highlighted characters indicate defaults.

Communications parameter setup

Before you carry out communications with the E5AN/EN/CN/GN, set up communications unit No., baud rate and other parameters by carrying out the following procedure. For details of operations other than communications parameter setup, refer to the E5AN/EN/CN/GN User's Manuals.

- (1) Hold down the  key for at least three seconds to move from the "operation level" to the "initial setting level."
- (2) Press the  key for less than one second to move from the "initial setting level" to the "communications setting level."
- (3) Select the parameters as shown below by pressing the  key.
- (4) Use the  or  keys to change the parameter set values.

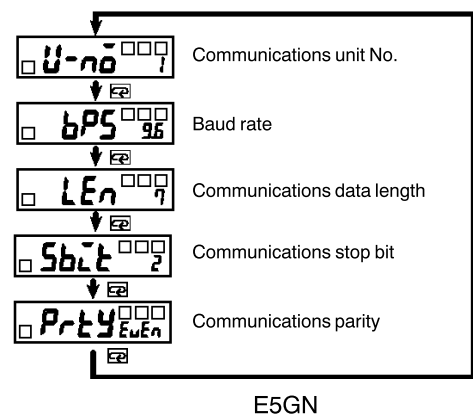
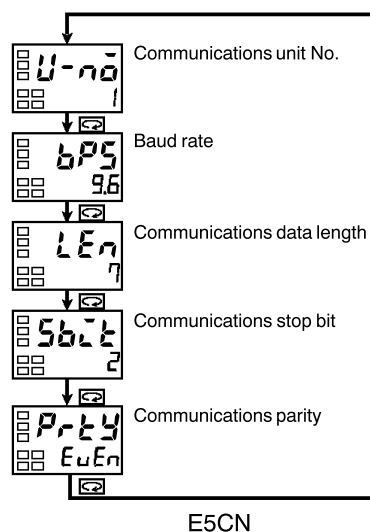
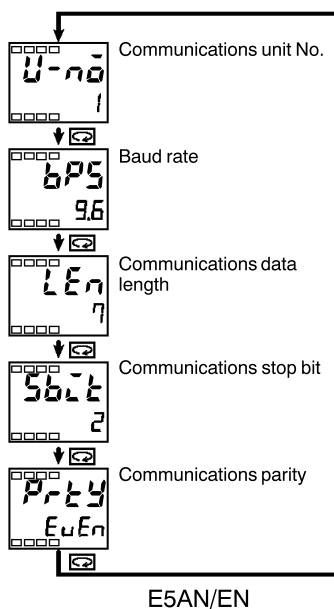

● Communications parameter setup

Note that communications parameters are enabled after they have been changed by resetting the controller.

- Communications unit No. (U-ŋā)

This parameter is for setting the unit No. to each of the temperature controllers. This unit No. is set so that the host computer can identify the temperature controller when communications are carried out with the host computer. Set a unit No. within the range 0 to 99 for each temperature controller connected to the host computer on the network. Default is “1”. When two or more temperature controllers are used, do not set the same unit No. Doing so will prevent normal operation.

- Baud rate (bP5)

This parameter is for setting the baud rate when communicating with the host computer. Set one of “1.2 (1200 bps)”, “2.4 (2400 bps)”, “4.8 (4800 bps)”, “9.6 (9600 bps)” and “19.2 (19200 bps)”.

- Communications data length (LĒŋ)

This parameter is for setting the communications data length. Set either of “7 bits” or “8 bits”.

- Communications stop bit (SbĀĒ)

This parameter is for setting the communications stop bit. Set either of “1” or “2”.

- Communications parity (P-ĒY)

This parameter is for setting the communications parity. Set one of “none”, “even” or “odd”.

CHAPTER 2

CompoWay/F COMMUNICATIONS PROCEDURES

Read this chapter if you are to communicate using the CompoWay/F format.

2.1	Data Format	2-2
	Command frame	2-2
	BCC calculation example	2-3
	Response frame	2-3
	Communications data	2-4
	Example of end code	2-4
2.2	Structure of Command Text	2-6
	PDU structure	2-6
	Area definitions	2-6
	Type code (variable type)	2-6
	Addresses	2-7
	Number of elements	2-7
	List of services	2-7
2.3	Details of Services	2-8
	Read from variable area	2-8
	Write to variable area	2-9
	Read controller attributes	2-11
	Read controller status	2-12
	Echoback test	2-13
	Operation instructions	2-14
2.4	Response Code List	2-17

2.1 Data Format

Unless otherwise indicated, numbers in this manual are expressed in hexadecimal. Values in double quotation marks, such as “00”, are ASCII.

The number underneath each delimiter in a frame indicates the number of bytes.

■ Command frame

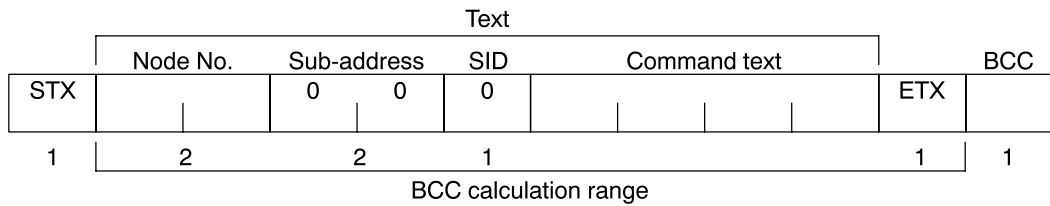

STX	This code (02) indicates the beginning of the communications frame (text). Always set this character in the first byte. When STX is received again during reception, reception is carried out again from the point where STX was received.
Node number	<ul style="list-style-type: none"> • This number specifies the transmission's destination. • Specify the E5AN/EN/CN/GN's "Communications unit No." • BCD range "00" to "99" and "XX" can be set. • Specify "XX" for a broadcast transmission. No response will be returned for broadcast transmissions. • No responses will be returned from node Nos. set otherwise from the above.
Sub-address	This is not used on the E5AN/EN/CN/GN. Be sure to set the sub-address to "00".
SID (service ID)	This is not used on the E5AN/EN/CN/GN. Be sure to set the sub-address to "00".
Command text	Command text area. For details, see "2.2 Structure of Command Text."
ETX	This code (03) indicates the end of the text.
BCC	Block Check Character The BCC result is found by calculating the exclusive OR of the bytes from the node No. up to ETX.

■ BCC calculation example

The BCC is formed by converting the 8-bit value obtained by converting the exclusive OR of the node No. up to ETX into two ASCII characters, and setting this to the BCC area.

STX	Node No.		Sub-address		SID	Command text				ETX	BCC
02H	0(30H)	0(30H)	0(30H)	0(30H)	0(30H)	0(30H)	5(35H)	0(30H)	3(33H)	03H	35H

$$\text{BCC} = 30\text{H} \oplus 30\text{H} \oplus 30\text{H} \oplus 30\text{H} \oplus 30\text{H} \oplus 30\text{H} \oplus 35\text{H} \oplus 30\text{H} \oplus 33\text{H} \oplus 03\text{H} = 35\text{H}$$

Calculation result 35H is set to the BCC area.

The \oplus symbol indicates exclusive OR operation and the H indicates hexadecimal code.

■ Response frame

STX	Node No.	Sub-address	End code	Command text	ETX	BCC
1	2	2	2		1	1

End code	Name	Description	Error Detection Priority
00	Normal completion	The command ended normally without error.	None
0F	FINS command error	The specified FINS command could not be executed. The FINS response code should indicate why the command could not be executed.	8
10	Parity error	The sum total of bits whose received data is "1" does not match the set value of "communications parity."	2
11	Framing error	Stop bit is "0".	1
12	Overrun error	An attempt was made to transfer new data when the reception data was already full.	3
13	BCC error	The calculated BCC value is different from the received BCC value.	5
14	Format error	<ul style="list-style-type: none"> The command text contains characters other than 0 to 9, and A to F. This error is not applicable to the echoback test. (For details, see chapters 2.3 "Echoback test.") No SID and command text. Or, no command text "MRC/SRC" not included in command text 	7
16	Sub-address error	<ul style="list-style-type: none"> Illegal (unsupported) sub-address No sub-address, SID and command text Sub-address less than two characters, and no SID and command text 	6
18	Frame length error	The received frame exceeds the fixed (supported) number of bytes.	4

- The end code is returned to received command frames addresses to the self node.
- No response will be returned if all the items in the response frame are incomplete up to the ETX and BCC.
- "Error Detection Priority" indicates the priority when two or more errors occur simultaneously.

■ Communications data

Communications specifications	Set (monitor) Value	Minus Value	Decimal point
CompoWay/F	8 digits (Hex)	2's complement	Decimal point is removed and the result is converted to hexadecimal. Example) 105.0 → 1050 → 000041A

■ Example of end code

The following examples show an end code when a command did not end normally.

Example 1) Illegal sub-address, and no SID and command text

Command Format

	Node No.	Sub-address	BCC
STX		0 A	ETX

Response Format

	Node No.	Sub-address	End code	BCC
STX		0 A	1 6	ETX

End code is "16" (sub-address error).

This is because a sub-address was received and the sub-address error has a higher error detection priority than the format error.

Example 2) No command text

Command Format

	Node No.	Sub-address	SID	BCC
STX		0 0	0	ETX

Response Format

	Node No.	Sub-address	End code	BCC
STX		0 0	1 4	ETX

End code is "14" (format error).

Example 3) All node Nos. not provided

Command Format

		BCC
STX		ETX

The node No. is lacking one character.

Response Format

No response

Example 4) No sub-address, and illegal BCC

Command Format

	Node No.		BCC
STX		ETX	Err

Response Format

	Node No.	Sub-address	End code		BCC
STX		0 0	1 3	ETX	

Sub-address is "00" and end code is "13" (BCC error).

2.2 Structure of Command Text

■ PDU structure

An MRC (Main Request Code) and SRC (Sub-Request Code) followed by the various required data is transferred to the command text.

Service request PDU



MRES (Main Response Code) and SRES (Sub-Response Code) are transferred following the above MRC/SRC. Data is then transferred following these MRES and SRES.

Service response PDU (during normal operation)

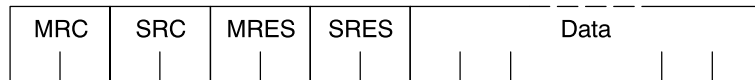

If the specified command text could not be executed, only the MRC/SRC and MRES/SRES become the target response PDUs.

Service response PDU (at non-execution of specified command text)

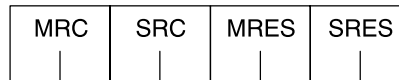

MRES/SRES becomes the response code except when processing ends in “normal completion.”

■ Area definitions

Areas comprise only variable area.

■ Type code (variable type)

The following defines variable area type codes.

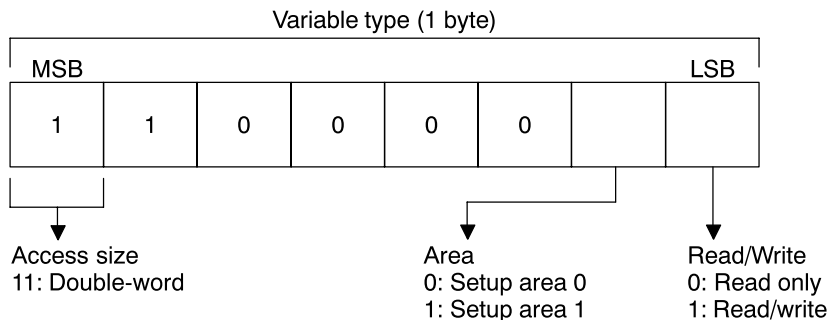

The following table summarizes setup areas 0 and 1.

Area	Description
Setup area 0	This area groups together the protect, operation and adjustment levels.
Setup area 1	This area groups together the initial setting, communications setting, advanced function setting and calibration levels.

The variable type is converted to 2-byte ASCII code and loaded to the frame. The following table shows actually existent variable types.

Variable type	Description
C0	Double-word data. R/O (read only) parameter for setup area 0.
C1	Double-word data. R/W parameter for setup area 0.
C3	Double-word data. R/W parameter for setup area 1.

* Setup area 1 has no R/O (read only) parameters. Therefore, variable type “C2” does not exist.

■ Addresses

Each of the variable types is appended with an address. Express addresses in 2-byte hexadecimal code, and append with its access size.

■ Number of elements

The number of elements is expressed in 2-byte hexadecimal code. Specify the number of elements within the range “0 to 2”.

For example, when the number of elements is “0002”, this specifies two items of data from the address.

■ List of services

MRC	SRC	Name of service	Process
01	01	Read from variable area	This service reads from variable areas.
01	02	Write to variable area	This service writes to variable areas.
05	03	Read controller attributes	This service reads the model No. and communications buffer size.
06	01	Read controller status	This service reads the run status of the controller.
08	01	Echoback test	This service carries out the echoback test.
30	05	Operation instructions	This service carries out run/stop, communications writing, write mode, save RAM data, AT (auto-tuning) execution/cancel, multi-SP, move to protect level, move to setup area 1 and software reset.

* In a memory error (RAM error) or initial state (until the control starts to look for the process value after the power is turned ON), all commands will not be accepted, and no response will be returned.

2.3 Details of Services

■ Read from variable area

This service reads from variable areas.

Service request PDU

MRC	SRC	Variable type	Read start address	Bit position	Number of elements
0 1	0 1			0 0	
2	2	2	4	2	4

Service response PDU

MRC	SRC	Response code	Read data (for number of elements)
0 1	0 1		
2	2	4	0 or 8 or 16

- (1) Variable type and read start address

For details on variable types and read start addresses, see “Chapter 3 Communications Data.”

- (2) Bit position

Bit accessing is not supported on the E5AN/EN/CN/GN. Fixed to “00”.

- (3) Number of elements

Number of elements	Process
0000	Read is not carried out (the service response PDU is not appended with read data), and processing ends in “normal completion.”
0001 to 0002	Read is carried out, and processing ends in “normal completion.”

- (4) Response code

At normal completion

Response code	Name	Description
0000	Normal completion	No errors were found.

At occurrence of error

Response code	Error name	Cause
1001	Command too long	The command is too long.
1002	Command too short	The command is too short.
1101	Area type error	The variable type is wrong.
1103	Start address out-of-range error	The read start address is out of range.
110B	Response too long	The number of elements is larger than “0002”.
1100	Parameter error	The bit position is other than “00”.
2203	Operation error	EEPROM error

(5) Precautions

● Alarm function

Even though alarms are not displayed on the controller's display, they are all functional in communications.

■ Write to variable area

This service writes to variable areas.

Service request PDU

MRC	SRC	Variable type	Write start address	Bit position	Number of elements	Write data (for number of elements)
0 1	0 2			0 0		
2	2	2	4	2	4	0 or 8 or 16

Service response PDU

MRC	SRC	Response code
0 1	0 2	
2	2	4

(1) Variable type and write start address

For details on variable types and write start addresses, see "Chapter 3 Communications Data."

(2) Bit position

Bit accessing is not supported on the EAN/5EN/CN/GN. Fixed to "00".

(3) Number of elements

Number of elements	Process
0000	Write is not carried out (the service response PDU is not appended with write data), and processing ends in "normal completion."
0001 to 0002	Write is carried out, and processing ends in "normal completion."

(4) Response code

At normal completion

Response code	Name	Description
0000	Normal completion	No errors were found.

At occurrence of error

Response code	Error name	Cause
1002	Command too short	The command is too short.
1101	Area type error	Wrong variable type
1103	Start address out-of-range error	Write start address is out of range.
1104	End address out-of-range error	The write end address (write start address + number of elements) exceeds the final address of the variable area.
1003	Number of elements/data mismatch	The number of data does not match the number of elements.
1100	Parameter error	<ul style="list-style-type: none"> • Bit position is other than "00". • Write data is out of setting range.
3003	Read-only data	Variable type "C0" was written to.
2203	Operation error	<ul style="list-style-type: none"> • The "communications writing" parameter is set to "OFF" (disabled). • Writing was carried out on the parameters from setup areas 0 to 1. • Writing was carried out on a protected parameter other than in the protect level. • Writing was carried out during AT execution. • EEPROM error

* For details on AT (auto-tuning), refer to the separate User's Manuals.

(5) Precautions

● Alarm function

Even though alarms are not displayed on the controller's display, they are all functional in communications.

Read controller attributes

This service reads the model No. and communications buffer size.

Service request PDU

MRC	SRC
0 5	0 3
2	2

Service response PDU

MRC	SRC	Response code	Model No.	Communications buffer size
0 5	0 3			0 0 2 8
2	2	4	10	4

(1) Model No.

The model No. is expressed in 10-byte ASCII code. Empty bytes are space codes.

Example :

The model No. for a unit equipped with relay output, HBA and communications functions is expressed as follows:

E	5	C	N	-	R	2	H	0	3
---	---	---	---	---	---	---	---	---	---

(2) Communications buffer size

The communications buffer size is expressed in 2-byte hexadecimal code, and read after being converted to 4-byte ASCII code.

Buffer size: 40 bytes (= H'0028)

(3) Response code

At normal completion

Response code	Name	Description
0000	Normal completion	No errors were found.

At occurrence of error

Response code	Name	Description
1001	Command too long	The command is too long.
2203	Operation error	EEPROM error

Read controller status

This service reads the run status of the controller.

Service request PDU

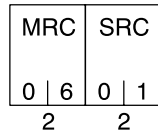

Service response PDU

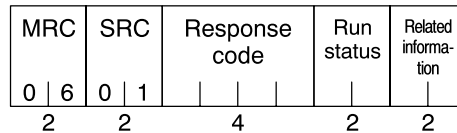

(1) Run status

Run status	Description
00	Control is being carried out (error has not occurred in setup area 0, and the controller is running).
01	Control is not being carried out (state other than above).

(2) Related information

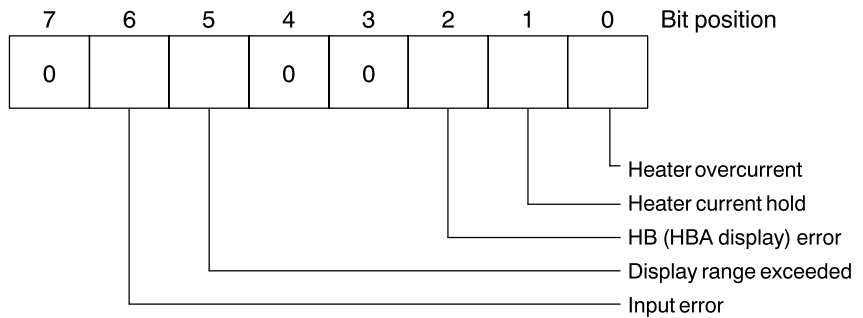

(3) Response code

At normal completion

Response code	Name	Description
0000	Normal completion	No errors were found.

At occurrence of error

Response code	Name	Description
1001	Command too long	The command is too long.
2203	Operation error	EEPROM error

■ Echoback test

This service carries out the echoback test.

Service request PDU

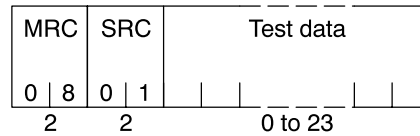

Service response PDU

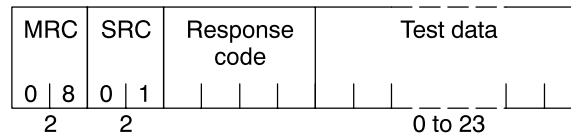

(1) Test data

Set any test data within the range “0” to “23”.

Set a value for the test data within the ranges shown below according to the communications data length.

Communications data length	Test data
8 bits	20 to 7E, A1 to FE converted to ASCII code
7 bits	20 to 7E converted to ASCII code

Do not set “40”. Doing so results in no response.

(2) Response code

At normal completion

Response code	Name	Description
0000	Normal completion	No errors were found.

At occurrence of error

Response code	Name	Description
1001	Command too long	The command is too long.
2203	Operation error	EEPROM error

■ Operation instructions

This service carries out run/stop, communications writing, write mode, save RAM data, AT (auto-tuning) execution/cancel, multi-SP, move to protect level, move to setup area 1 and software reset.

Service request PDU

MRC	SRC	Instruc- tion code	Related informa- tion
3 0	0 5		
2	2	2	2

Service response PDU

MRC	SRC	Response code
3 0	0 5	
2	2	4

(1) Instruction code and related information

Instruction code	Description	Related information
00	Communications writing	00: OFF (disabled) 01: ON (enabled)
01	Run/Stop	00: Run 01: Stop
02	Multi-SP	00: Set point 0 01: Set point 1 02: Set point 2 03: Set point 3
03	AT execute/cancel	00: Cancel 01: AT execute
04	Write mode	00: Backup 01: RAM
05	Save RAM data	00
06	Software reset *	00
07	Move to setup area 1	00
08	Move to protect level	00

* No response will be returned when a software reset is carried out.

(2) Response code

At normal completion

Response code	Name	Description
0000	Normal completion	No errors were found.

At occurrence of error

Response code	Error name	Cause
1001	Command too long	The command is too long.
1002	Command too short	The command is too short.
1100	Parameter error	Instruction code and related information are wrong.
2203	Operation error	<ul style="list-style-type: none"> • The “communications writing” parameter is set to “OFF” (disabled). However, note that the error is accepted regardless of the “communications writing” parameter setting (ON/OFF). • The command cannot be processed. For details, see “(3) Description of operating instructions and precautions” below. • EEPROM error

(3) Description of operation instructions and precautions

● Communications writing

Set the “communications writing” parameter to “ON: enabled” or “OFF: disabled” according to related information. This instruction can be accepted at both setup areas 0 and 1.

● Run/Stop

Set control to “run” or “stop” according to related information. This instruction can be accepted at both setup areas 0 and 1.

● AT execute/cancel

Set AT (auto-tuning) to “execute” or “cancel” according to related information. This instruction can be accepted at setup area 0 only. However, note that an “operation error” is generated in the following instances:

- When the “run/stop” parameter is set to “stop”
- When the instruction is issued in “setup area 1”
- When the ON/OFF control

● Write mode

Set either the backup mode or RAM write mode according to related information. This instruction can be accepted at both setup areas 0 and 1.

● Multi-SP

Set four set points beforehand in the adjustment level so that you switch to a desired set point.

Write mode	Description
Backup mode	Writing is carried out to EEPROM when the parameters in the operation/adjustment levels (excluding R/O parameters) are written by communications.
RAM write mode	Writing is not carried out to EEPROM when the parameters in the operation/adjustment levels (excluding R/O parameters) are written by communications. However, note that parameters can be changed by operating the keys on the front panel of the controller.

- When the RAM write mode is changed to the backup mode, the parameters in the operation/adjustment levels (excluding R/O parameters) are written to EEPROM.
- The RAM write mode is enabled only when the “communications writing” parameter is set to “ON: enabled”. So, when the “communications writing” parameter setting is changed to “OFF: disabled”, the parameters in the operation/adjustment levels (excluding R/O parameters) are written to EEPROM even if the RAM write mode is set to “disabled.”
- Save RAM data
This instruction writes the parameters in the operation/adjustment levels (excluding R/O parameters). This instruction can be accepted at both setup areas 0 and 1.
- Software reset
This instruction resumes processing after the power is turned OFF. This instruction can be accepted at both setup areas 0 and 1. No response will be returned for this operation instruction.
- Move to setup area 1
This instruction moves to “setup area 1” and can be accepted at both setup areas 0 and 1. However, note that when “initial setup/communications protection” is set to “2”, an “operation error” is generated, and move to setup area 1 is forbidden.
When this move is carried out from setup area 0, the display indicates the “input type” in the “initial setting level.” When this operation instruction is issued in setup area 1, the display will not change.
- Move to protect level
This instruction moves to the “protect level” and can be accepted only in setup area 0. When this instruction command is issued in setup area 1, an “operation error” is generated, and move to setup area 1 is forbidden.

2.4 Response Code List

At normal completion

Response code	Name	Description	Error detection priority
0000	Normal completion	No errors were found.	None

At occurrence of error

Response code	Name	Description	Error detection priority
0401	Unsupported command	The service function for the relevant command is not supported.	1
1001	Command too long	The command is too long.	2
1002	Command too short	The command is too short.	3
1101	Area type error	The variable type is wrong.	4
1103	Start address out-of-range error	The read/write start address is out of range.	5
1104	End address out-of-range error	The write end address (write start address + number of elements) exceeds the final address of the variable area.	6
1003	Number of elements/data mismatch	The number of data does not match the number of elements.	7
110B	Response too long	The response exceeds the communications buffer size (when larger than number of elements 0002).	8
1100	Parameter error	<ul style="list-style-type: none"> • The bit position is other than "00". • The write data is out of the setting range. • The instruction code and related information in the operating instruction is wrong. 	9
3003	Read-only error	Variable type "C0" was written to.	10
2203	Operation error	<ul style="list-style-type: none"> • The "communications writing" parameter is set to "OFF" (disabled). • Writing was carried out on the parameters from setup areas 0 to 1. • Writing was carried out on a protected parameter other than in the protect level. • Writing was carried out during AT execution. • Processing is not possible by operating instruction. • EEPROM error 	11

CHAPTER 3

COMMUNICATIONS DATA

This chapter lists the details of each of the communications data in the CompoWay/F and Sysway communications procedures.

3.1	Variable Area (setup range) List	3-2
3.2	Status	3-8

3.1 Variable Area (setup range) List

The following table lists the variable areas. Items expressed in hexadecimal in the “Set (monitor) Value” column are the setting range in the CompoWay/F specifications. Values in parentheses “()” are the actual setting range. (Refer to these values for the setting range in the Sysway specifications.)

For details of variable areas that are described not in numerical values but by text, refer to the relevant parameter descriptions.

Variable type	Address	Item	Set (monitor) Value	Level
C0	0000	Process value	Temperature: Follow the specified range of the sensor.	Operation
			Analog: Scaling lower limit -5%FS to scaling upper limit +5%FS	
C0	0001	Status *	See “4.2 Status.”	
C0	0002	Internal set point *	SP lower limit to SP upper limit	
C0	0003	Heater current monitor	00000000 to 00000226 (0.0 to 55.0)	
C0	0004	MV monitor (heat)	Standard : FFFFFFFCE to 0000041A (-5.0 to 105.0)	
			Heating and cooling: 00000000 to 0000041A (0.0 to 105.0)	
C0	0005	MV monitor (cool)	00000000 to 0000041A (0.0 to 105.0)	

* Not displayed on the controller display.

Variable type	Address	Item	Set (monitor) Value	Level
C1	0000	Operation/adjustment protection	00000000(0): No restrictions in operation and adjustment levels 00000001(1): Move to adjustment level restricted 00000002(2): Display and change of only "PV" and "PV/SP" parameters enabled 00000003(3): Display of only "PV" and "PV/SP" parameters enabled	Protect
C1	0001	Initial setting/communications protection	00000000(0): Move to initial setting/communications setting level enabled (move to advanced function setting level displayed) 00000001(1): Move to initial setting/communications setting level enabled (move to advanced function setting level not displayed) 00000002(2): Move to initial setting/communications setting level restricted	
C1	0002	Setup change protection	00000000(0): OFF (changing of setup on controller display enabled) 00000001(1): ON (changing of setup on controller display disabled)	
C1	0003	Set point	SP lower limit to SP upper limit	Operation
C1	0004	Alarm value 1	FFFFFF831 to 0000270F (-1999 to 9999)	
C1	0005	Upper-limit alarm 1	FFFFFF831 to 0000270F (-1999 to 9999)	
C1	0006	Lower-limit alarm 1	FFFFFF831 to 0000270F (-1999 to 9999)	
C1	0007	Alarm value 2	FFFFFF831 to 0000270F (-1999 to 9999)	
C1	0008	Upper-limit alarm 2	FFFFFF831 to 0000270F (-1999 to 9999)	
C1	0008	Lower-limit alarm 2	FFFFFF831 to 0000270F (-1999 to 9999)	
C1	000A	Alarm value 3 *	FFFFFF831 to 0000270F (-1999 to 9999)	
C1	000B	Upper-limit alarm 3 *	FFFFFF831 to 0000270F (-1999 to 9999)	
C1	000C	Lower-limit alarm 3 *	FFFFFF831 to 0000270F (-1999 to 9999)	
C1	000D	Heater burnout detection	00000000 to 000001F4 (0.0 to 50.0)	Adjustment
C1	000E	Set point 0	SP lower limit to SP upper limit	
C1	000F	Set point 1	SP lower limit to SP upper limit	
C1	0010	Set point 2	SP lower limit to SP upper limit	
C1	0011	Set point 3	SP lower limit to SP upper limit	
C1	0012	Temperature input shift	FFFFFF831 to 0000270F (-199.9 to 999.9)	
C1	0013	Upper-limit temperature input shift value	FFFFFF831 to 0000270F (-199.9 to 999.9)	
C1	0014	Lower-limit temperature input shift value	FFFFFF831 to 0000270F (-199.9 to 999.9)	
C1	0015	Proportional band	00000001 to 0000270F (0.1 to 999.9)	
C1	0016	Integral time	00000000 to 00000F9F (0 to 3999)	
C1	0017	Derivative time	00000000 to 00000F9F (0 to 3999)	
C1	0018	Cooling coefficient	00000001 to 0000270F (0.01 to 99.99)	

* Only displayed on the E5EN/AN-□3□□□

The alarm function can be also be utilized on units without alarm output terminals. In this case, confirm alarm occurrences via the status data.

Variable type	Address	Item	Set (monitor) Value	Level
C1	0019	Dead band	FFFFFF831 to 0000270F (-199.9 to 999.9)	Adjustment
C1	001A	Manual reset value	00000000 to 000003E8 (0.0 to 100.0)	
C1	001B	Hysteresis (OUT1)	00000001 to 0000270F (0.1 to 999.9)	
C1	001C	Hysteresis (OUT2)	00000001 to 0000270F (0.1 to 999.9)	
C3	0000	Input type *	00000000(0): Pt (-200 to 850°C/-300 to 1500°F) 00000001(1): Pt (-199.9 to 500.0°C/-199.9 to 900.0°F) 00000002(2): Pt (-0.0 to 100.0°C/-0.0 to 210.0°F) 00000003(3): Jpt (-199.9 to 500.0°C/-199.9 to 900.0°F) 00000004(4): Jpt (-0.0 to 100.0°C/0.0 to 210.0°F) 00000000(0): K (-200 to 1300°C/-300 to 2300°F) 00000001(1): K (-20.0 to 500.0°C/0.0 to 900.0°F) 00000002(2): J (-100 to 850°C/-100 to 1500°F) 00000003(3): J (-20.0 to 400.0°C/0.0 to 750.0°F) 00000004(4): T (-200 to 400°C/-300 to 700°F) 00000005(5): E (0 to 600°C/0 to 1100°F) 00000006(6): L (-100 to 850°C/-100 to 1500°F) 00000007(7): U (-200 to 400°C/-300 to 700°F) 00000008(8): N (-200 to 1300°C/-300 to 2300°F) 00000009(9): R (0 to 1700°C/0 to 3000°F) 0000000A(10): S (0 to 1700°C/0 to 3000°F) 0000000B(11): B (100 to 1800°C/300 to 3200°F) 0000000C(12): Infrared temperature sensor (K10 to 70°C) 0000000D(13): Infrared temperature sensor (K60 to 120°C) 0000000E(14): Infrared temperature sensor (K115 to 165°C) 0000000F(15): Infrared temperature sensor (K160 to 260°C) 00000010(16): 0 to 50mV 00000011(17): T (-199.9 to 400.0°C/-199.9 to 700.0°F) 00000012(18): U (-199.9 to 400.0°C/-199.9 to 700.0°F)	Initial setting
C3	0001	Scaling upper limit	Scaling lower limit +1 to 0000270F (scaling lower limit +1 to 9999)	
C3	0002	Scaling lower limit	FFFFFF831 to Scaling upper limit -1 (-1999 to scaling upper limit -1)	
C3	0003	Decimal point	00000000 to 00000001 (0 to 1)	

* The input type can be selected according to the connected sensor. Two input type specifications are supported, “platinum resistance thermometer” and “thermocouple and infrared temperature sensor.”





Variable type	Address	Item	Set (monitor) Value	Level
C3	0004	°C/°F selection	00000000(0):°C 00000001(1):°F	Initial setting
C3	0005	SP upper limit	Temperature: SP lower limit +1 to Input range upper limit	
			Analog: SP lower limit +1 to scaling upper limit	
C3	0006	SP lower limit	Temperature: Input range lower limit to SP upper limit -1	
			Analog: Scaling lower limit to SP upper limit -1	
C3	0007	PID/ ON/OFF	00000000(0): ON/OFF 00000001(1): 2-PID	
C3	0008	Standard/Heating and cooling	00000000(0): Standard 00000001(1): Heating and cooling	
C3	0009	ST	00000000(0): OFF 00000001(1): ON	
C3	000A	Control period (OUT1)	00000001 to 00000063 (1 to 99)	
C3	000B	Control period (OUT2)	00000001 to 00000063 (1 to 99)	
C3	000C	Direct/reverse operation	00000000(0): Reverse operation 00000001(1): Direct operation	
C3	000D	Alarm 1 type	00000000(0): Alarm function OFF	
			00000001(1): Upper- and lower-limit alarm	
			00000002(2): Upper-limit alarm	
			00000003(3): Lower-limit alarm	
			00000004(4): Upper- and lower-limit range alarm	
			00000005(5): Upper- and lower-limit alarm with standby sequence	
			00000006(6): Upper-limit alarm with standby sequence	
			00000007(7): Lower-limit alarm with standby sequence	
			00000008(8): Absolute-value upper-limit alarm	
			00000009(9): Absolute-value lower-limit alarm	
			0000000A(10): Absolute-value upper-limit alarm with standby sequence	
0000000B(11): Absolute-value lower-limit alarm with standby sequence				
C3	000E	Alarm 2 type	Same as alarm 1 type	
C3	000F	Alarm 3 type *	Same as alarm 1 type	

* The alarm function can be also be utilized on units without alarm output terminals. In this case, confirm alarm occurrences via the status data.

Variable type	Address	Item	Set (monitor) Value	Level
C3	0010	Communications unit No. *1	00000000 to 00000063 (0 to 99)	Communica-tions setting
C3	0011	Baud rate *1	00000000(0): 1.2 00000001(1): 2.4 00000002(2): 4.8 00000003(3): 9.6 00000004(4): 19.2	
C3	0012	Communications data length *1	00000007(7): 7 00000008(8): 8	
C3	0013	Communications stop bit *1	00000001(1): 1 00000002(2): 2	
C3	0014	Communications parity	00000000(0): None 00000001(1): Even 00000002(2): Odd	
C3	001A	Multi-SP	00000000(0): OFF 00000001(1): ON	Advanced func-tion setting
C3	001B	Spare		
C3	001C	SP ramp set value	00000000(0): OFF 00000001 to 0000270F (1 to 9999)	
C3	001D	Standby sequence reset method	00000000(0): Condition A 00000001(1): Condition B	
C3	001E	Alarm 1 open in alarm	00000000(0): Close in alarm 00000001(1): Open in alarm	
C3	001F	Alarm 1 hysteresis	00000001 to 0000270F (0.1 to 999.9)	
C3	0020	Alarm 2 open in alarm	00000000(0): Close in alarm 00000001(1): Open in alarm	
C3	0021	Alarm 2 hysteresis	00000001 to 0000270F (0.1 to 999.9)	
C3	0022	Alarm 3 open in alarm*	00000000(0): Close in alarm 00000001(1): Open in alarm	
C3	0023	Alarm 3 hysteresis	00000001 to 0000270F (0.1 to 999.9)	
C3	0024	HBA used	00000000(0): OFF 00000001(1): ON	
C3	0025	Heater burnout latch	00000000(0): OFF 00000001(1): ON	
C3	0026	Heater burnout hysteresis	00000001 to 00001F4 (0.1 to 50.0)	
C3	0027	ST stable range	00000001 to 0000270F (0.1 to 999.9)	
C3	0028	α	00000000 to 00000064 (0.00 to 1.00)	

*1 Communications parameters are enabled after they have been changed by resetting the controller.

* The alarm function can be also be utilized on units without alarm output terminals. In this case, confirm alarm occurrences via the status data.

Variable type	Address	Item	Set (monitor) Value	Level
C3	0029	MV upper limit	Standard: MV lower limit +0.1 to 000041A (MV lower limit +0.1 to 105.0)	Advanced function setting
			Heating and cooling: 00000000 to 0000041A (0.0 to 105.0)	
C3	002A	MV lower limit	Standard: FFFFFFFCE to MV upper limit -0.1 (-5.0 to MV upper limit -0.1)	
			Heating and cooling: FFFFFBE6 to 00000000 (-105.0 to 0.0)	
C3	002B	Input digital filter	00000000 to 0000270F (0.0 to 999.9)	
C3	002C	Additional PV display	00000000(0): OFF 00000001(1): ON	
C3	002D	MV display	00000000(0): OFF (display of manipulated variable OFF) 00000001(1): ON (display of manipulated variable ON)	
C3	002E	Automatic return of display mode	00000000(0): OFF 00000001 to 00000063 (1 to 99)	
C3	002F	Alarm 1 latch	00000000(0): OFF 00000001(1): ON	
C3	0030	Alarm 2 latch	00000000(0): OFF 00000001(1): ON	
C3	0031	Alarm 3 latch	00000000(0): OFF 00000001(1): ON	
C3	0032	Protect level move time	00000001 to 0000001E (1 to 30)	
C3	0033	Input error output	00000000(0): OFF 00000001(1): ON	
C3	0034	Cold junction compensation method	00000000(0): OFF 00000001(1): ON	
C3	0035	MB command logic switching*1	00000000(0): OFF 00000001(1): ON	
C3	0036	PV color change*2	00000001(1):  Red 00000002(2):  Green 00000003(3):  Red→Green ALM1 lit : Green 00000004(4):  Green→Red ALM1 lit : Red 00000005(5):  Red→Green→Red Within PV stable band : Green Outside the stable band : Red	
C3	0037	PV stable band*2	00000001 to 0000270F (0.1 to 999.9)	

*1 The logic is switched only in MB command (Sysway).

The logic of CompoWay/F operation instruction code 00 (communications writing) is not influenced.

*2 Applies to the E5CN only.

3.2 Status

The figure below shows the structure of the status data:

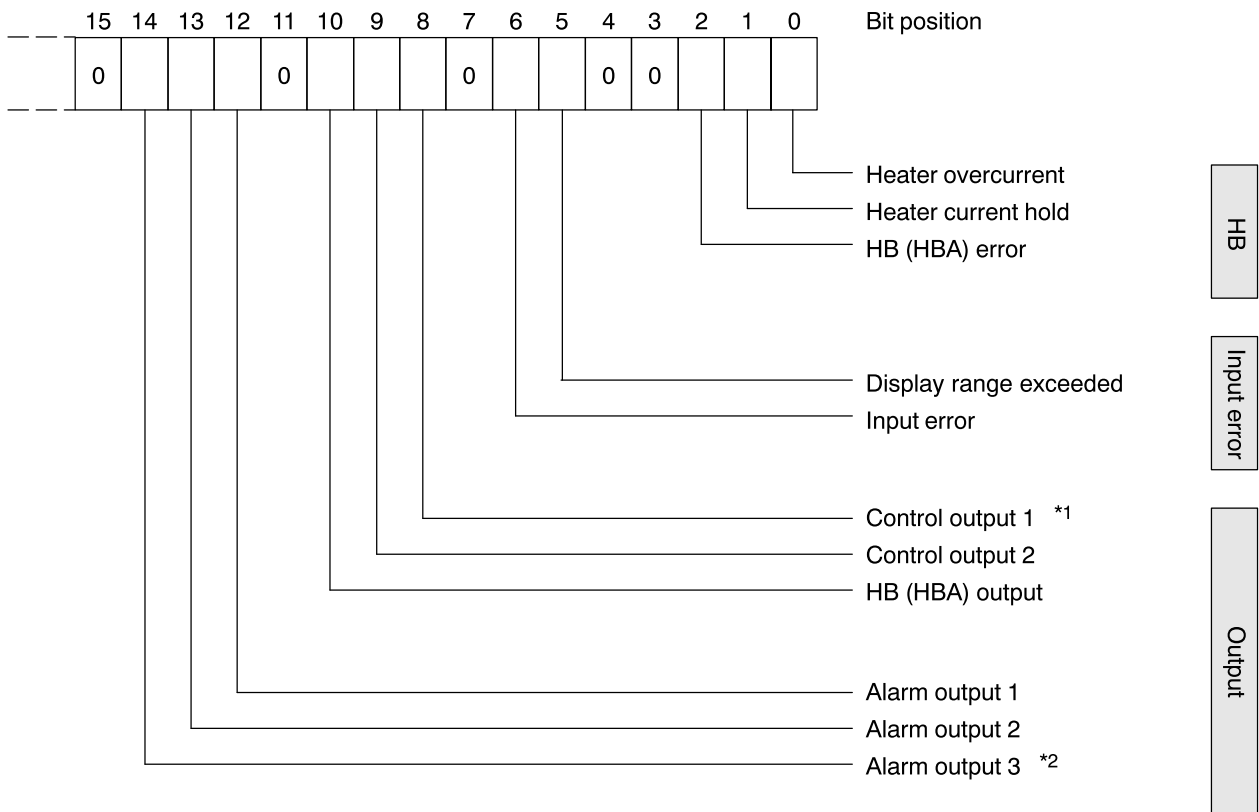

*1 Whenever the control output is the current output, this data bit is 0.

*2 Applies to the E5EN/AN-□3□□□ only.

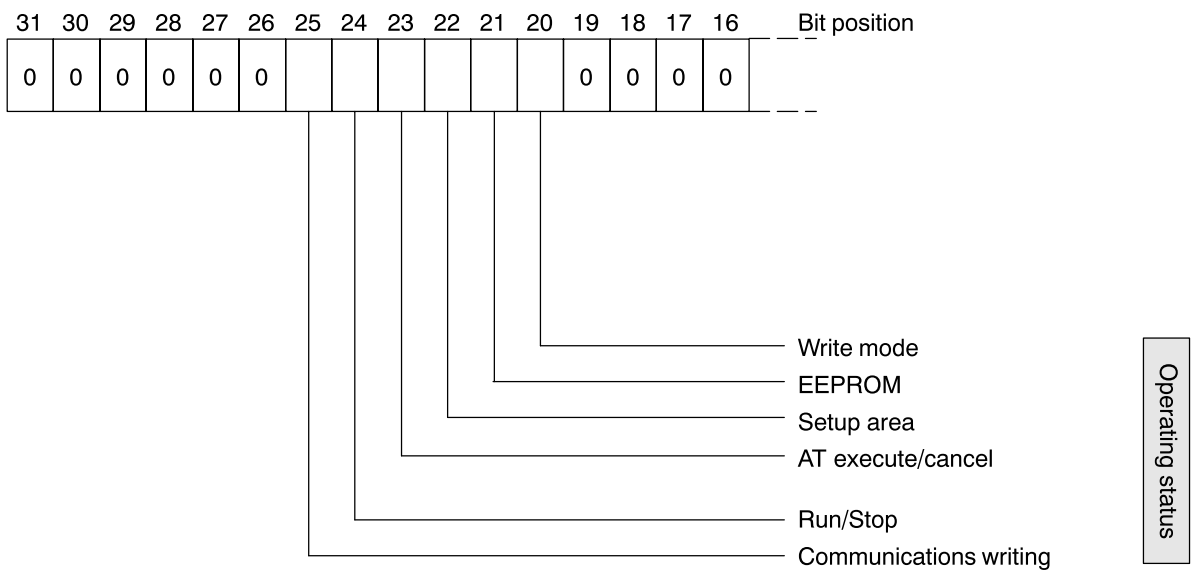

The following shows the status contents.

Bit position	Status	Bit Description	
		0	1
0	Heater overcurrent	Not generated	Generated
1	Heater current hold *1	Updated	Hold
2	HB (HBA) error	Not generated	Generated
3	Spare		
4	Spare		
5	Display range exceeded	Not generated	Generated
6	Input error	Not generated	Generated
7	Spare		
8	Control output 1 *2	OFF	ON
9	Control output 2	OFF	ON
10	HB (HBA) output	OFF	ON
11	Spare		
12	Alarm output 1	OFF	ON
13	Alarm output 2	OFF	ON
14	Alarm output 3 *3	OFF	ON
15	Spare		
16	Spare		
17	Spare		
18	Spare		
19	Spare		
20	Write mode	Backup mode	RAM write mode
21	EEPROM	RAM=EEPROM	RAM≠EEPROM
22	Setup area	Setup area 0	Setup area 1
23	AT execute/cancel	AT canceled	AT execution in progress
24	Run/Stop	Run	Stop
25	Communications writing	OFF (disabled)	ON (enabled)
26	Spare		
27	Spare		
28	Spare		
29	Spare		
30	Spare		
31	Spare		

*1 “1” is set and the heater current is held at the immediately previous current value when the control output ON time is less than 190 ms.

*2 Whenever the control output is the current output, this is OFF.

* “Spare” bits are always OFF.

CHAPTER 4

Sysway (E5□J, □X format)

COMMUNICATIONS PROCEDURES

These communications procedures are supported for ensuring compatibility with existing temperature controller models E5□J and E5□X.

4.1	Data Format	4-2
	Command frame format	4-2
	FCS calculation example	4-2
	Response frame	4-3
	Communications data	4-3
	Sysway command lists	4-4
4.2	Command Descriptions	4-5
	Read process value	4-5
	Write set value	4-6
	Read set value and MV monitor	4-7
	Communications writing switching	4-8

4.1 Data Format

■ Command frame format

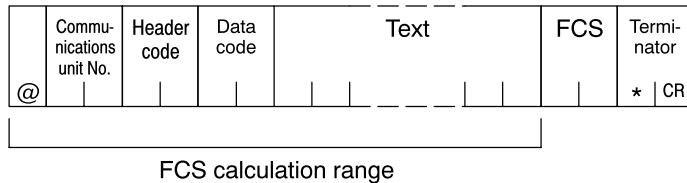

@	Character (40) that indicates the start of block format
Communications unit No.	A number within the range 0 to 99 can be set in BCD. No response will be returned if a number other than this is set.
Header code	2-character alphabet code that indicates the command type
Data code	Set "02" only when reading and writing alarm value 2. Otherwise, set "01".
Text	This area stores read values, write values and status. The content of this area varies according to the command.
FCS	The FCS (Frame Check Sequence) is formed by converting the value obtained by converting the exclusive OR of @ to the last text character into ASCII characters.
Terminator	Indicates the end of the block format. Comprises "*" and CR (Character Return 0D)

■ FCS calculation example

The FCS is formed by converting the 8-bit value obtained by converting the exclusive OR of start character "@" up to the last text character into two ASCII characters, and setting this to the FCS area.

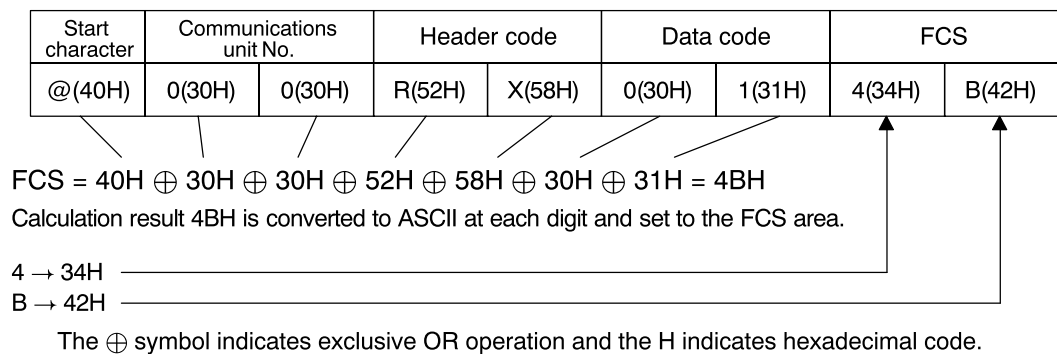

Response frame

@	Communi- cations unit No.	Header code	End code	Text	FCS	Termi- nator
						* CR

End code	Name	Description	Priority
10	Parity error	The sum total of bits whose received data is "1" does not match the set value of "communications parity."	1
11	Framing error	Stop bit is "0".	2
12	Overrun error	An attempt was made to transfer new data when the reception data was already full.	3
13	FCS error	The calculated FCS value is different from the received FCS value.	4
IC*	Undefined error	The header code of the command cannot be interpreted.	5
14	Format error	<ul style="list-style-type: none"> The command length is incorrect. 	6
0D	Non-executable command	<ul style="list-style-type: none"> The set value was written when the "communications writing" parameter was set to "OFF" (disabled). The set value was written during AT execution. 	7
15	Undefined data value	<ul style="list-style-type: none"> The write data is either outside the setting range or not a numerical value. The data is either outside the setting range or not a numerical value. 	8
00	Normal completion	The command ended normally without error.	—

* The response format for an "undefined error" differs from the regular response format in that an error code not an "end code" is stored to the "header code."

Response format in the case of an undefined error

@	Communi- cations unit No.	Header code	FCS	Termi- nator
		I C		* CR

Communications data

Communications specifications	Set (monitor) Value	Minus Value	Decimal Point
Sysway	Four digits (decimal)	If the uppermost digit is "-1", the uppermost digit is set to "A". Example) -1999 → A999 If the uppermost digit is "-", the uppermost digit is set to "F". Example) -10 → F010	The decimal point is removed. Example) 105.0 → 1050

Sysway command lists

Category	Header code	Data code	Command	R/W	Data length	Remarks
Communications writing selection	MB	01	Select communications writing	W	4B	
Write mode selection	ME	01	Select backup mode	W	None	
	MA	01	Select RAM write mode			
Save run/adjustment set value	MW	01	Save operation/adjustment set value			
Write set value	WS	01	Write set point	W	4B	
	W%	01	Write alarm value 1			
	W%	02	Write alarm value 2			
	WB	01	Write proportional band			
	WN	01	Write integral time			
	WV	01	Write derivative time			
	WI	01	Write temperature input shift values			
WW	01	Write heater burnout detection				
Read set value and manipulated variable monitor	RS	01	Read set point	R	4B	
	R%	01	Read alarm value 1			
	R%	02	Read alarm value 2			
	RB	01	Read proportional band			
	RN	01	Read integral time			
	RV	01	Read derivative time			
	RI	01	Read input shift values			
	RW	01	Read temperature heater burnout detection			
RO	01	Read MV monitor				
Read SP upper and lower limit values	RL	01	Read SP upper and lower limit values	R	8B	Read both upper/lower limit values at once
Read process value	RX	01	Read the process value	R	8B	*1
	RZ	01	Read the heater current monitor			
Read initial status	RU	01	Read the initial status	R	5B	*2

* In a memory error (RAM error) or initial state (until the control starts to look for the process value after the power is turned ON), no commands will be accepted, and no response will be returned.

* When writing is carried out when a memory error (RAM error) has occurred, writing to EEPROM is not carried out, and processing ends in “normal completion.” Reading is as normal.

*1 Status

*2 Status

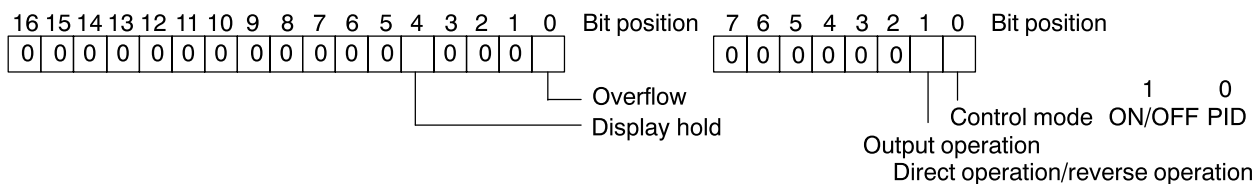

* Overflow: Set 1 when the heater current value is greater than 55.0 A.

* Display hold: Set 1 when the control output ON time is less than 190 ms. The previous heater current value is held.

4.2 Command Descriptions

■ Read process value

This command reads the process value and status.

Command Format

	Communi- cations unit No.	Header code	Data code	FCS	Termi- nator
@		R X	0 1		* CR

Response Format

	Communi- cations unit No.	Header code	End code	Process value	Status	FCS	Termi- nator
@		R X					* CR

(1) Process value

See “Chapter 3 Communications Data.”

(2) Status

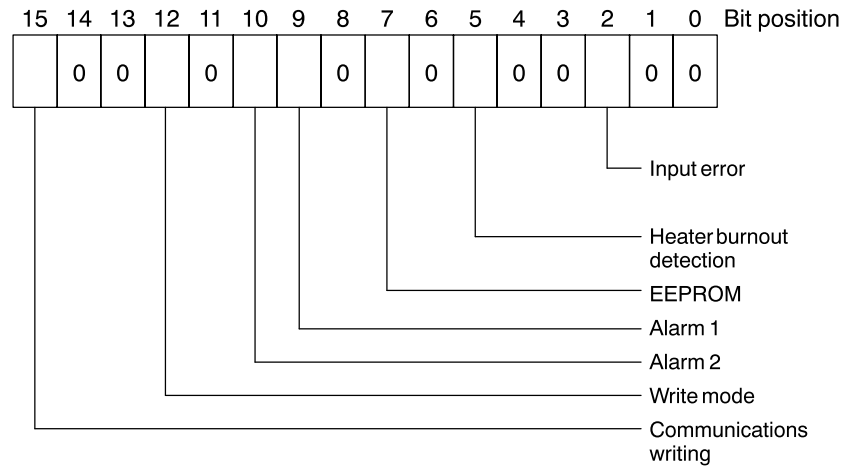

Item	Description	
	0	1
Input error	Not generated	Generated
Heater burnout detection	OFF or does not function	ON
EEPROM	RAM=EEPROM	RAM≠EEPROM
Alarm 1	OFF or does not function	ON
Alarm 2	OFF or does not function	ON
Write mode	Backup mode	RAM write mode
Communications writing	OFF (disabled) or does not function	ON (enabled)

(3) End code

When the end code is “00”, this indicates normal completion of the command. Otherwise, the command could not be processed. For details on end codes, see “Response frame” on page 4-3.

(4) Precautions

- Even though alarms 1 and 2 are not displayed on the controller’s display, they are all functional in communications.
- When the controller has moved to setting area 1, the previous state is held. “Setting area 1” is where the initial setting, communications setting, advanced function setting and calibration levels are grouped together.

■ Write set values

This command writes the set point, alarm values 1 and 2, proportional band, integral time, derivative time, temperature input shift values and heater burnout detection.

Command Format

@	Commu- nications unit No.	Header code	Data code	Write value	FCS	Termi- nator
						* CR

Response Format

@	Commu- nications unit No.	Header code	End code	FCS	Termi- nator
					* CR

(1) Header code

Header Code	Command
WS	Write set point
W%	Write alarm value 1/2
WB	Write proportional band
WN	Write integral time
WV	Write derivative time
WI	Write temperature input shift values
WW	Write heater burnout detection

(2) Data code

Only “write to alarm value 2” is set to “02”. All other settings are “01”.

(3) Write value

For details on the write value (set value) range, see “Chapter 3 Communications Data.”

(4) Precautions

● Alarm values 1 and 2

When “alarm 1 type” is set to one of “upper/lower-limit alarm,” “upper/lower-limit range alarm” or “upper/lower-limit alarm with standby sequence”, “alarm value 1” is disabled as the upper and lower limits of the alarm are set independently. “Upper-limit alarm value 1” and “lower-limit alarm value 1” become the alarm set values.

For this reason, when “upper/lower-limit alarm” is set, write values are written by communications to “upper-limit alarm value 1” and “lower-limit alarm value 1” and not to “alarm value 1.” The same applies to “alarm 2 type.”

- Temperature input shift values

When “input type” is set to “non-contact temperature sensor,” “temperature input shift values” is disabled as temperature input is shifted by 2-point shift. The values set to the “upper-limit temperature input shift value” and “lower-limit temperature input shift value” parameters are the set values used for temperature input shift.

For this reason, when 2-point shift is adopted, write values are written by communications to “upper-limit temperature input shift value” and “lower-limit temperature input shift value” and not to “temperature input shift values.”

- Alarms

Alarms 1 and 2 can be used normally in communications. However, alarm 3 cannot be used.

■ Read set value and MV monitor

This command reads the set point, alarm values 1 and 2, proportional band, integral time, derivative time, temperature input shift values, heater burnout detection and MV monitor.

Command Format

	Commu- nications unit No.	Header code	Data code	FCS	Termi- nator
@					* CR

Response Format

	Commu- nications unit No.	Header code	End code	Write value	FCS	Termi- nator
@						* CR

(1) Header code

Header Code	Command
RS	Read set point
R%	Read alarm value 1/2
RB	Read proportional band
RN	Read integral time
RV	Read derivative time
RI	Read input shift values
RW	Read temperature heater burnout detection
RO	Read MV monitor

(2) Data code

Only “write to alarm value 2” is set to “02”. All other settings are “01”.

(3) Read value

For details on the read value (set value) range, see “Chapter 3 Communications Data.”

(4) Precautions

● Alarm values 1 and 2

When “alarm 1 type” is set to one of “upper/lower-limit alarm,” “upper/lower-limit range alarm” or “upper/lower-limit alarm with standby sequence”, “alarm value 1” is disabled as the upper and lower limits of the alarm are set independently. “Upper-limit alarm value 1” and “lower-limit alarm value 1” become the alarm set values.

For this reason, when “upper/lower-limit alarm” is set, the value of “upper-limit alarm value 1” and not “alarm value 1” is the value read by communications.

The same applies to “alarm 2 type.”

● Temperature input shift values

When “input type” is set to “non-contact temperature sensor,” “temperature input shift values” is disabled as temperature input is shifted by 2-point shift. The values set to the “upper-limit temperature input shift value” and “lower-limit temperature input shift value” parameters are the set values used for temperature input shift.

For this reason, when 2-point shift is adopted, the value of “upper-limit temperature input shift value” and not “temperature input shift values” is the value read by communications.

● Alarms

Alarms 1 and 2 can be used normally in communications. However, alarm 3 cannot be used.

■ **Communications writing switching**

The logic of the MB command changes as shown in the table below according to the MB command logic switching setting (advanced function level). The MB command (communications writing switching) is equivalent to the MB command (remote/local switching) on the E5□J.

Text Data of MB Command	MB Command Logic Switching Setting	
	OFF	ON
0000	Communications writing enabled (remote mode selection)	Communications writing disabled (local mode selection)
0001	Communications writing disabled (local mode selection)	Communications writing enabled (remote mode selection)

- MB command logic switching default : OFF (same logic as E5□J)



APPENDIX



ASCII List	A-2
------------------	-----

ASCII LIST (ANSI X 3.4-1986)

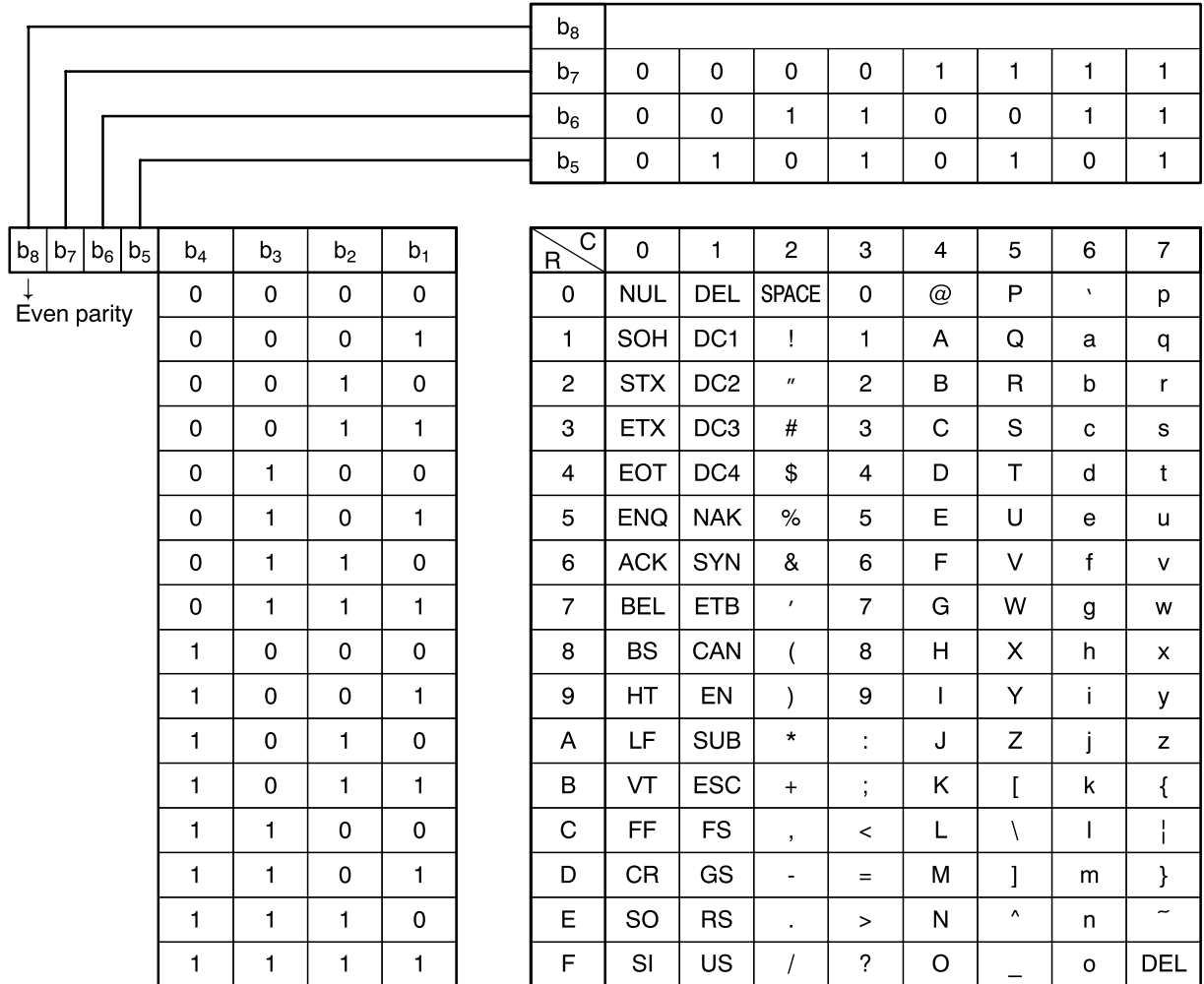

- A**
Addresses 2-7
Area definitions 2-6
ASCII list A-2
- B**
BCC 1-2, 2-2, 2-3, 2-5
- C**
Command descriptions 4-5
Command frame 1-3, 2-2
Command frame format 4-2
Command text 2-2, 2-6
Communications data 2-4, 3-1, 4-3
Communications data length ... 1-5, 1-6, 3-6
Communications methods 1-1, 1-2
Communications parameters 1-5
Communications parity 1-5, 1-6, 3-6
Communications specifications 1-2, 1-4
Communications stop bit 1-5, 1-6, 3-6
Communications unit No. 1-5, 1-6, 3-6
Communications writing switching 4-8
CompoWay/F 1-2, 2-1, 3-1, 3-2
- D**
Data format 2-2, 4-2
Details of services 2-8
- E**
Echoback test 2-7, 2-13
End code 2-3, 2-4, 4-6, 4-7
ETX 2-2, 2-3
- F**
FCS 4-2, 4-3
FCS calculation example 4-2
FINS 1-2, 2-3
- I**
Interface 1-2, 1-3
- L**
List of services 2-7
- N**
Number of elements 2-7
- O**
Operation instructions 2-7, 2-15
- P**
PDU 2-6, 2-11
- R**
Read controller attributes 2-7, 2-11
Read controller status 2-7, 2-12
Read from variable area 2-7, 2-8
Read initial status 4-4
Read process value 4-4, 4-5
Read set value and MV monitor 4-7
Read SP upper and lower limit values .. 4-4
Response code list 2-17
Response frame 2-3, 4-3
- S**
SID 2-2, 2-4
Status 3-8
STX 2-2, 2-4
Sysway command lists 4-4
- T**
Transmission procedure 1-3
Type code (variable type) 2-6
- V**
Variable area (setup range) list 3-2
- W**
Wiring 1-3
Write set values 4-6
Write to variable area 2-7, 2-9

Revision History

A manual revision code appears as a suffix to the catalog number on the front cover of the manual.

Cat. No. H102-E1-04



Revision code

The following table outlines the change made to the manual during each revision. Page numbers refer to previous version

Revision code	Data	Revised content
1	October 1998	Original production
2	March 1999	<p>All pages: Changed "E5CN/GN" to "E5EN/CN/GN".</p> <p>Page III: Modified the torque value.</p> <p>Page IV: Modified "(6)" in "NOTICE".</p> <p>Page 1-2: Modified the table and note in "Communications specifications".</p> <p>Page 1-3: Modified the diagram in "Wiring".</p> <p>Page 1-4: Added "RS-232C" description.</p> <p>Page 1-5: Added the E5EN diagram in "Communications parameter setup".</p> <p>Page 2-11: Modified the example in "(1) Model No.".</p> <p>Page 2-16: Deleted "Note".</p> <p>Page 3-1: Replace "Chapter 3" to "Chapter 4".</p> <p>Page 3-3: Added "Note".</p> <p>Page 3-4: Modified the set value in "Scaling lower limit".</p> <p>Page 3-5: Added "Note".</p> <p>Page 3-7: Added "Note".</p> <p>Page 3-7: Changed "C1" to "C3" in variable type.</p> <p>Page 3-7: Modified the set value in "MV lower limit".</p> <p>Page 3-8: Added "Notes".</p> <p>Page 3-10: Modified the status contents.</p>
3	April 2000	<p>All pages: Changed "E5/EN/CN/GN" to "E5AN/EN/CN/GN".</p> <p>Page 1-2: Modified the item of "Transmission line connection" on the table.</p> <p>Page 3-6 to 3-7: Modified "Variable Area (setup range) List".</p> <p>Page 4-8: Added "Communications writing switching".</p>
4	July 2002	<p>Page 3-3 to 3-4: Modified "Variable Area (setup range) List".</p> <p>Page 3-7: Modified "Variable Area (setup range) List".</p>

OMRON

OMRON Corporation
Industrial Automation Company

Measuring and Control Division

Shiokoji Horikawa,
Shimogyo-ku, Kyoto,
600-8530 Japan
Tel: (81)75-344-7080/Fax: (81)75-344-7189

Regional Headquarters

OMRON EUROPE B.V.

Wegalaan 67-69, NL-2132 JD Hoofddorp
The Netherlands
Tel: (31)2356-81-300/Fax: (31)2356-81-388

OMRON ELECTRONICS, INC.

1 East Commerce Drive, Schaumburg, IL 60173
U.S.A.
Tel: (1)847-843-7900/Fax: (1)847-843-8568

OMRON ASIA PACIFIC PTE. LTD.

83 Clemenceau Avenue, #11-01, UE Square,
239920 Singapore
Tel: (65)835-3011/Fax: (65)835-2711

OMRON CHINA CO., LTD.

BEIJING OFFICE

Room 1028, Office Building, Beijing Capital
Times Square, No.88 West Chang'an Road,
Beijing, 100031 China
Tel: (86)10-8391-3005/Fax: (86)10-8391-3688

Authorized Distributor: