

# Modular Temperature Controller E5ZN

## New DIN Track Mounting Temperature Controller

- Two channels of temperature control available despite width of only 22.5 mm.
- The Temperature Controller itself can be replaced without changing terminal wiring.
- Use in combination with a compact Setting Display Unit to reduce communications programming requirements.
- A wide variety of operation indicators (single-color LEDs) enable easy operation monitoring.
- Power supply and communications wiring not required between Units when mounted side-by-side.

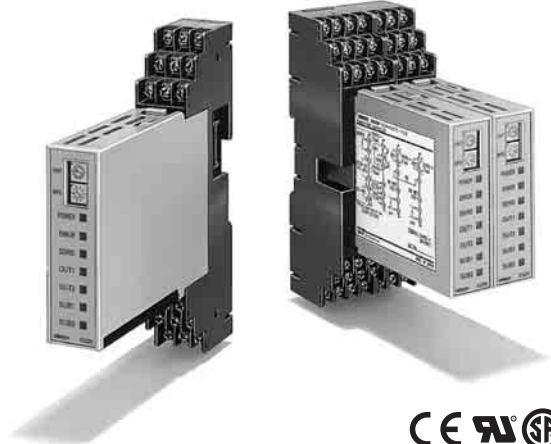

## Model Number Structure

### ■ Model Number Legend

E5ZN- 2 □ □ □ □ □ -FLK  
 1 2 3 4 5 6 7

- Control points**  
2: Two points
- Control output**  
Q: Voltage (for driving SSR)  
T: Transistor  
C: Current
- Auxiliary output**  
P: Transistor (sourcing)  
N: Transistor (sinking)
- Option**  
H: Heater burnout alarm  
F: Transfer output
- Communications**  
03: RS-485
- Input type**  
TC: Thermocouple  
P: Platinum resistance thermometer
- CompoWay/F serial communications**  
-FLK: CompoWay/F serial communications

# Ordering Information

## ■ List of Models

Name	Power supply	No. of control points	Control output	Auxiliary output	Functions	Communications functions	Input type (See note 5.)	Model	
Temperature Controller (See note 1.)	24 VDC	2	Voltage output (for SSRs)	Transistor output: 2 pts (sinking)	Heater burnout alarm (See note 3.)	RS-485	Thermocouple	E5ZN-2QNH03TC-FLK	
				Transistor output: 2 pts (sourcing)			Platinum resistance thermometer	E5ZN-2QNH03P-FLK	
				Transistor output			Transistor output: 2 pts (sinking)	Thermocouple	E5ZN-2QPH03TC-FLK
							Transistor output: 2 pts (sourcing)	Platinum resistance thermometer	E5ZN-2QPH03P-FLK
			Analog output (current output) (See note 2.)	Transfer output (linear voltage output) (See note 2.)	Thermocouple		E5ZN-2TNH03TC-FLK		
					Platinum resistance thermometer		E5ZN-2TNH03P-FLK		
				Transfer output (linear voltage output) (See note 2.)	Thermocouple		E5ZN-2TPH03TC-FLK		
					Platinum resistance thermometer		E5ZN-2TPH03P-FLK		
			Transfer output (linear voltage output) (See note 2.)	Transfer output (linear voltage output) (See note 2.)	Thermocouple		E5ZN-2CNF03TC-FLK		
					Platinum resistance thermometer		E5ZN-2CNF03P-FLK		
				Transfer output (linear voltage output) (See note 2.)	Thermocouple		E5ZN-2CPF03TC-FLK		
					Platinum resistance thermometer		E5ZN-2CPF03P-FLK		

- Note:**
- Terminal Units are required for wiring. Purchase separately.
  - When connecting the load of the controlled system, heat control output or cool control output can be allocated to the control output or auxiliary output. When connecting a recording device or Digital Panel Meter, transfer output can be allocated to control output or auxiliary output 3 or 4 of analog output models.
  - When using the heater burnout alarm, purchase a Current Transformer (CT) separately.
  - When using heating and cooling control functionality, the auxiliary output will be either heating control output or cooling control output.
  - Analog input and infrared temperature sensors (ES1A-A) can also be used with thermocouple models.

Name	No. of terminals	Functions	Model
Terminal Unit (Includes bus system without backplane.)	24	Equipped with communications terminals for power supply, communications, and setting devices.	E5ZN-SCT24S-500
	18 (See note 1.)	Not equipped with communications terminals for power supply, communications, and setting devices.	E5ZN-SCT18S-500

- Note:**
- When using 2 or more E5ZNs mounted side-by-side, use the E5ZN-SCT18S-500 for the second and subsequent Units. When using E5ZNs separately, be sure to use the E5ZN-SCT24S-500.
  - Two End Plates are provided with E5ZN-SCT24S-500 Terminal Units. When mounting to a DIN track, be sure to mount End Plates on both sides.

### Current Transformer (CT) (Order Separately)

Model	E54-CT1	E54-CT3
Diameter	5.8 dia.	12.0 dia.

### Terminal Cover

Model	E53-COV12	E53-COV13
Type	For SCT24S-500 models	For SCT18S-500 models

**Note:** The Terminal Cover comes with the Terminal Unit and does not have to be purchased separately.

### Sockets (for Setting Display Unit - Order Separately)

Model	P2CF-11	P2CF-11-E	P3GA-11	Y92A-48G
Type	Front-connecting socket	Front-connecting socket (with finger protection)	Back-connecting socket	Terminal cover for finger protection

**Note:** Refer to the following manual for precautionary information and other information necessary to use the E5ZN: E5ZN Temperature Controller Operation Manual (Cat. No. H113).

### Setting Display Unit (Order Separately)

Name	Power supply	Model
Setting Display Unit (See note.)	24 VDC	E5ZN-SDL

**Note:** Purchase sockets for wiring (shown on page 2) separately.

# Specifications

## ■ Ratings

Power supply voltage	24 VDC					
Allowable voltage range	85% to 110% of the rated power supply voltage					
Power consumption	Approx. 3 W					
Sensor input	Thermocouple: K, J, T, E, L, U, N, R, S, B Infrared temperature sensor (ES1A series): 10 to 70°C, 60 to 120°C, 115 to 165°C, 160 to 260°C (See note 1.) Voltage input: 0 to 50 mV					
	Platinum resistance thermometer: Pt100, JPt100					
Control output	Voltage output (for driving SSR)	Output voltage: 12 VDC ±15% (PNP); Maximum load current: 21 mA; Equipped with short-circuit protection circuit				
	Transistor output	Maximum operational voltage: 30 VDC; Maximum load current: 100 mA; Residual voltage: 1.5 V max.; Leakage current: 0.4 mA max.				
	Current output	Current output range: 4 to 20/0 to 20 mA DC; Load: 350 Ω max. (See note 2.)				
Auxiliary output	Transistor output	<table border="1"> <tr> <td>Sourcing</td> <td>Maximum operating voltage: 30 VDC; Maximum load current: 50 mA; Residual voltage: 1.5 V max.;</td> </tr> <tr> <td>Sinking</td> <td>Leakage current: 0.4 mA max.</td> </tr> </table>	Sourcing	Maximum operating voltage: 30 VDC; Maximum load current: 50 mA; Residual voltage: 1.5 V max.;	Sinking	Leakage current: 0.4 mA max.
	Sourcing	Maximum operating voltage: 30 VDC; Maximum load current: 50 mA; Residual voltage: 1.5 V max.;				
Sinking	Leakage current: 0.4 mA max.					
Linear voltage output	Voltage output range: 1 to 5/0 to 5 VDC; Load: 10 kΩ min.					
Event input	Contact output	ON: 1 kΩ max., OFF: 100 kΩ min. Discharge current: Approx. 7 mA				
	Non-contact output	ON: Residual voltage: 1.5 V max., OFF: Leakage current: 0.1 mA max. Discharge current: Approx. 7 mA				
Number of input and control points	Input points: 2, Control points: 2					
Setting method	Via communications or using the Setting Display Unit (E5ZN-SDL)					
Control method	2-PID or ON/OFF control					
Other functions	Heater burnout detection function, transfer output function Multi-SP and RUN/STOP switching using event input					
Ambient operating temperature	-10 to 55°C (with no icing or condensation) For 3 years of assured use: -10 to 50°C					
Ambient operating humidity	25% to 85%					
Storage temperature	-25 to 65°C (with no icing or condensation)					

**Note:** 1. ES1A models with a temperature range of 160°C to 260°C have been discontinued.  
2. OMRON G32A-EA Cycle Controller Unit (load impedance 352 Ω) can be used.

## ■ Input Range

### Platinum Resistance Thermometer Models and Thermocouple Models

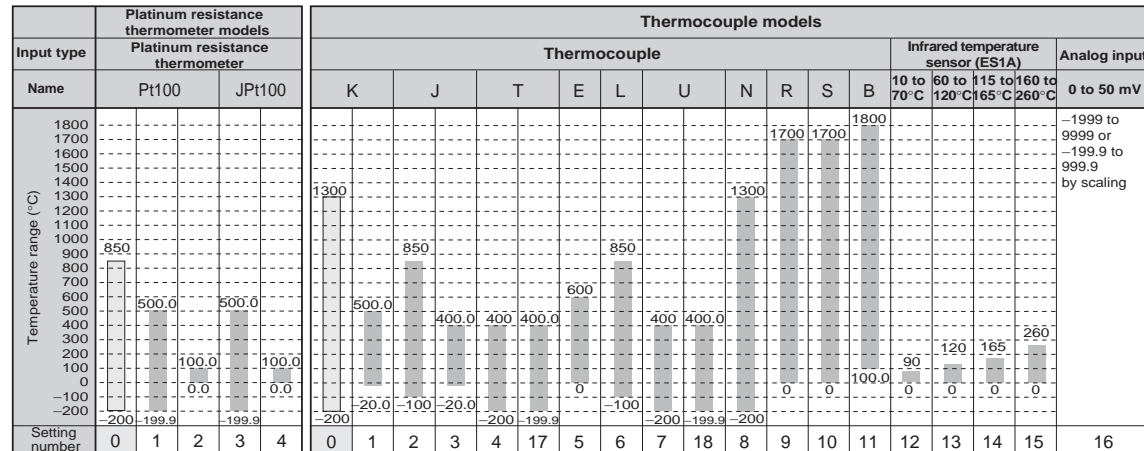

The applicable standards for the input types are as follows:

- K, J, T, E, N, R, S, B: JIS C1602-1995, IEC584-1
- L: Fe-CuNi, DIN 43710-1985
- U: Cu-CuNi, DIN 43710-1985
- JPt100: JIS C 1604-1989, JIS C 1606-1989
- Pt100: JIS C 1604-1997 IEC 751

Shaded parts indicate the settings at the time of purchase.

**Note:** ES1A models with a temperature range of 160°C to 260°C have been discontinued.

## ■ Characteristics

<b>Indication accuracy</b>	Thermocouple: (Indicated value $\pm 0.5\%$ or $\pm 1^\circ\text{C}$ , whichever is greater) $\pm 1$ digit max. (See note 1.) Platinum resistance thermometer: (Indicated value $\pm 0.5\%$ or $\pm 1^\circ\text{C}$ , whichever is greater) $\pm 1$ digit max. (See note 1.) Analog input: $\pm 0.5\%$ or $\pm 1$ digit max. CT input: $\pm 5\%$ FS $\pm 1$ digit max.
<b>Transfer output</b>	Accuracy: $\pm 0.5\%$ FS (See note 2.)
<b>Hysteresis</b>	0.1 to 999.9 EU (in units of 0.1 EU) (See note 3.)
<b>Proportional band (P)</b>	0.1 to 999.9 EU (in units of 0.1 EU) (See note 3.)
<b>Integral time (I)</b>	0 to 3,999 s (in units of 1 s)
<b>Derivative time (D)</b>	0 to 3,999 s (in units of 1 s)
<b>Control period</b>	1 to 99 s (in units of 1 s)
<b>Manual reset value</b>	0.0 to 100.0% (in units of 0.1%)
<b>Alarm setting range</b>	-1,999 to 9,999 (Position of decimal point depends on input type.)
<b>Sampling period</b>	500 ms
<b>Insulation resistance</b>	20 M $\Omega$ min. (at 500 VDC)
<b>Dielectric strength</b>	600 VAC for 1 minute at 50 or 60 Hz (between unlike terminals of charged parts)
<b>Vibration resistance</b>	10 to 55 Hz, 10 m/s <sup>2</sup> for 2 hrs each in X, Y, and Z directions
<b>Shock resistance</b>	150 m/s <sup>2</sup> max., 3 times each in $\pm X$ , $\pm Y$ , and $\pm Z$ directions
<b>Enclosure rating</b>	Temperature Controller: IP00 Terminal Unit: IP00
<b>Memory protection</b>	EEPROM (non-volatile memory) (Number of write operations: 100,000)
<b>Weight</b>	Temperature Controller: Approx. 90 g Terminal Unit (18): Approx. 80 g Terminal Unit (24): Approx. 100 g
<b>Approved standards (See note 4.)</b>	UL File No.: E200593 CSA File No.: 203889-1140084 CE EMS: ESD EN61326, EN61000-4-2 (4 kV/contact, 8 kV/air) REM field EN61326, EN61000-4-3 (10 V/m) Fast transient EN61326, EN61000-4-4 (2 kV/DC power, 1 kV/I/O) Surge immunity EN61326, EN61000-4-5 (line to ground: 2 kV/DC power 1 kV/I/O line to line: 1 kV/DC power) Conducted RF EN61326, EN61000-4-6 (10 V) EMI: Radiated EN61326 Class A

- Note:**
1. The indication accuracy for T and N thermocouples at  $-100^\circ\text{C}$ , and for U and L thermocouples is  $\pm 2^\circ\text{C} \pm 1$  digit max. There is no specification for the indication accuracy for the B thermocouple used at  $400^\circ\text{C}$  max. The indication accuracy for R and S thermocouples at  $200^\circ\text{C}$  max. is  $\pm 3^\circ\text{C} \pm 1$  digit max.
  2. The transfer output accuracy for 0 to 4 mA when 0 to 20 mA DC is selected is  $\pm 0.5\%$  FS +0.7 mA. The transfer output accuracy for 0 to 1 V when 0 to 5 VDC is selected is  $\pm 0.5\%$  FS +0.175 V.
  3. "EU" stands for "Engineering Unit."
  4. In order to satisfy the EN61326 Class A standard for conducted emissions, install a noise filter (Densei-Lambda MXB-1206-33 or equivalent) in a DC power line as close to the E5ZN as possible.

## ■ Communications (Host Communications)

Transmission line connection method	RS-485 multipoint
Communications method	RS-485 (2-wire, half-duplex)
Synchronization method	Start-stop synchronization
Baud rate	4,800, 9,600, 19,200, or 38,400 bps
Transmission code	ASCII
Data bit length (See note.)	7 or 8 bits
Stop bit length (See note.)	1 or 2 bits
Error detection	Vertical parity (none, even, odd) BCC (block check character)
Flow control	None
Interface	RS-485
Retry function	None
Number of Units that can be connected in parallel	16 Units max. (32 channels)

**Note:** The baud rate, data bit length, stop bit length, and vertical parity can all be set independently as host communications settings.

## ■ Setting Display Unit (Order Separately) Ratings and Characteristics

Power supply voltage	24 VDC
Allowable voltage range	85% to 110% of the rated power supply voltage
Power consumption	Approx. 1 W
Display method	7-segment digital display and single-color display
Ambient operating temperature	-10 to 55°C (with no icing or condensation) For 3 years of assured use: -10 to 50°C
Ambient operating humidity	25% to 85%
Storage temperature	-25 to 65°C (with no icing or condensation)
Communications method	RS-485 (half-duplex)
Communications format	Fixed
Insulation resistance	20 MΩ min. (at 500 VDC)
Dielectric strength	1,500 VAC for 1 minute at 50 or 60 Hz (between unlike terminals of charged parts)
Vibration resistance	10 to 55 Hz, 20 m/s <sup>2</sup> for 2 hrs each in X, Y, and Z directions
Shock resistance	300 m/s <sup>2</sup> max., 3 times each in ±X, ±Y, and ±Z directions
Enclosure ratings	Front panel: IP50 Rear case: IP20 Terminal case: IP00
Memory protection	EEPROM (non-volatile memory) (Number of writes: 100,000)
Weight	Approx. 100 g Mounting bracket: Approx. 10 g

## ■ Current Transformer (CT) Ratings (Order Separately)

Dielectric strength	1,000 VAC (1 minute)
Vibration resistance	50 Hz, 98 m/s <sup>2</sup>
Weight	E54-CT1: Approx. 11.5 g E54-CT3: Approx. 50 g
Accessories (E54-CT3 only)	Armature (2) Plug (2)

## ■ Heater Burnout Alarm Characteristics

Maximum heater current	Single-phase, 50 A AC (See note 1.)
Input current readout accuracy	±5% FS ±1 digit max.
Heater burnout alarm setting range	0.0 to 50.0 A (in units of 0.1 A) (See note 2.)
Minimum detection ON time	190 ms (See note 3.)

- Note:**
1. Use the K2CU-F□□A-□GS (with GATE input terminal) for burnout detection of 3-phase heaters.
  2. If the heater burnout alarm setting is set to 0.0 A, the alarm is always OFF, and if it is set to 50.0 A the alarm is always ON.
  3. If the ON time for control output is less than 190 ms, heater burnout detection and heater current measurement will not be performed.

# Nomenclature

## E5ZN-2

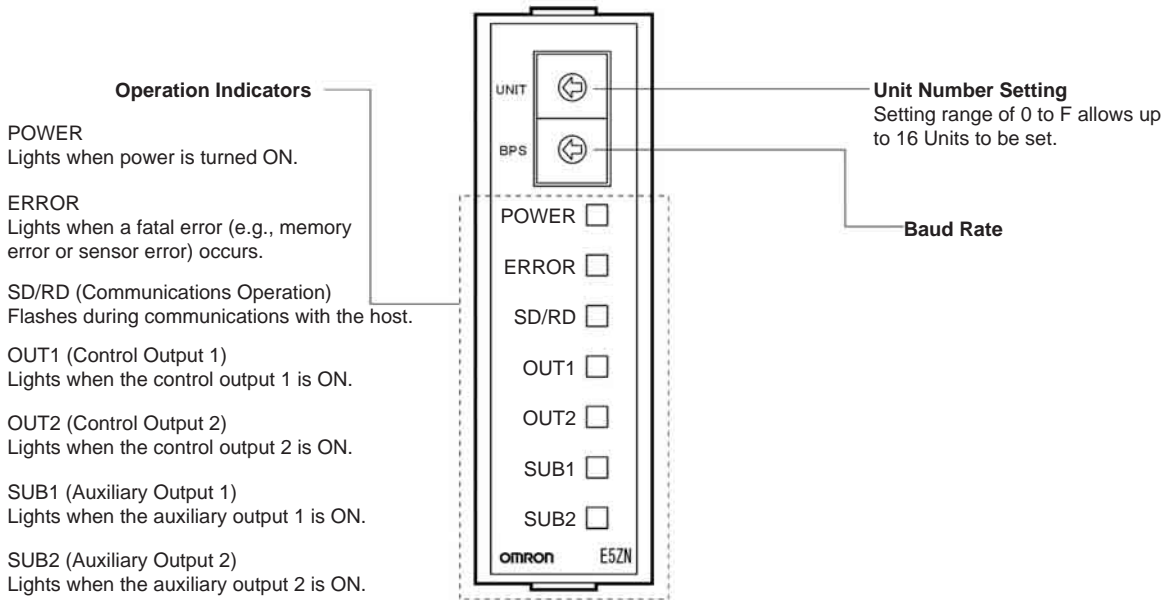

## E5ZN-SDL

The following diagram shows the names and functions of the E5ZN-SDL parts for when it is connected to the E5ZN-2□□□□□□□□.

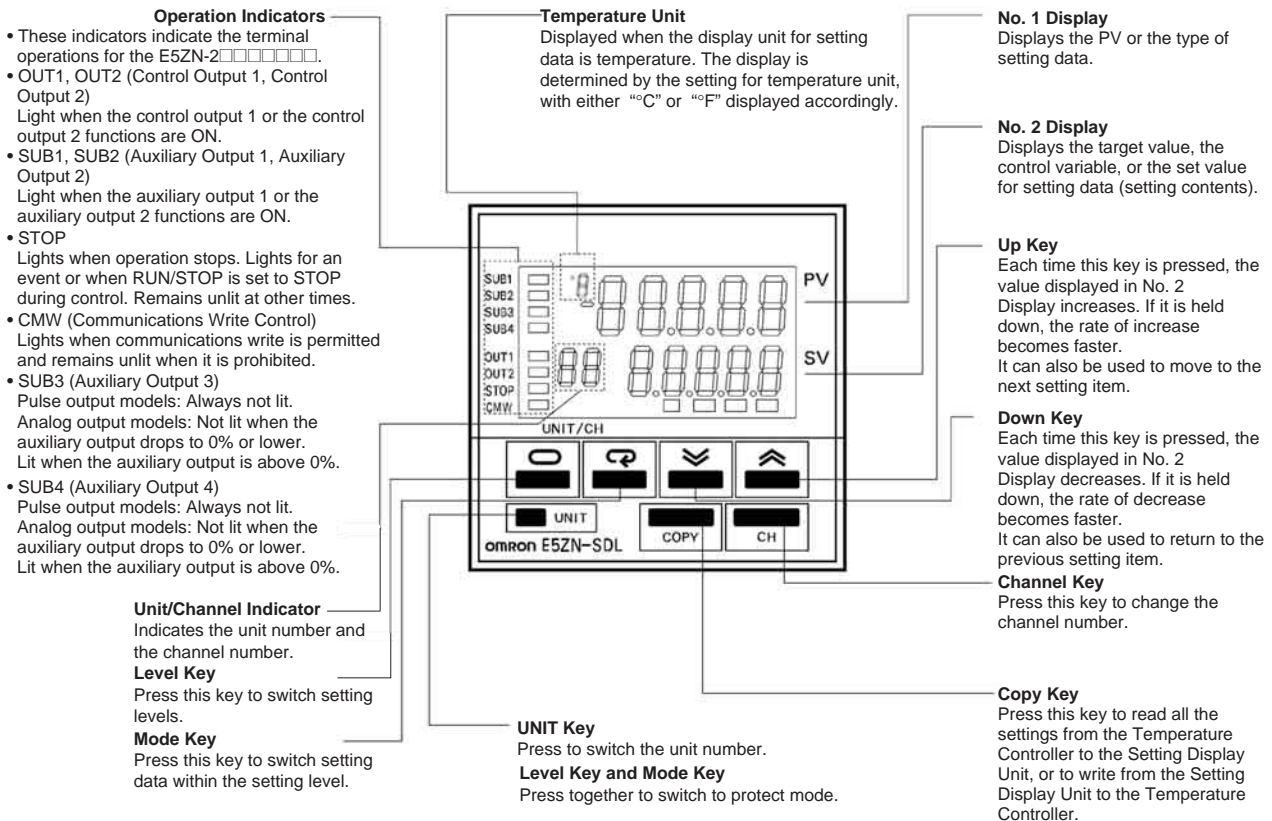

# Dimensions

**Note:** All units are in millimeters unless otherwise indicated.

## E5ZN-2□□□03□-FLK Connected to E5ZN-SCT24S-500

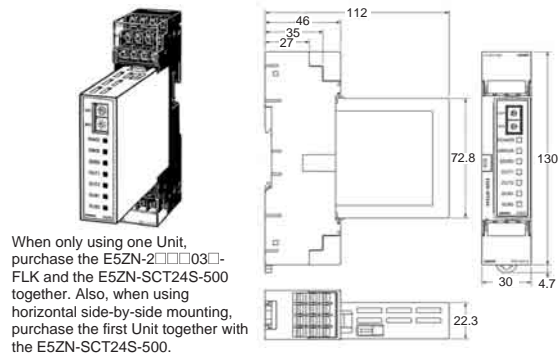

When only using one Unit, purchase the E5ZN-2□□□03□-FLK and the E5ZN-SCT24S-500 together. Also, when using horizontal side-by-side mounting, purchase the first Unit together with the E5ZN-SCT24S-500.

## E5ZN-2□□□03□-FLK Connected to E5ZN-SCT18S-500

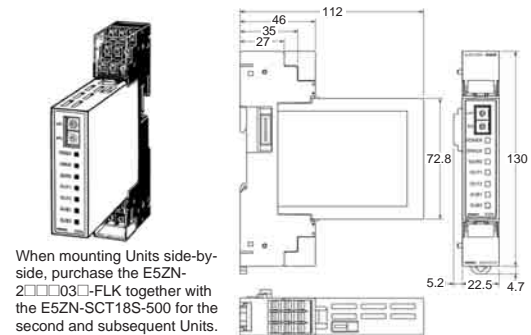

When mounting Units side-by-side, purchase the E5ZN-2□□□03□-FLK together with the E5ZN-SCT18S-500 for the second and subsequent Units.

**Note:** Refer to the following manual for precautionary information and other information necessary to use the E5ZN: E5ZN Modular Temperature Controller User's Manual (Cat. No. H113).

## End Plate

### PPF-M

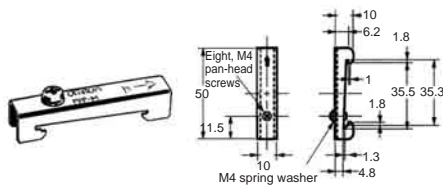

**Note:** End Plates are provided with the E5ZN-SCT24-500. Be sure to mount End Plates at both ends of Unit blocks.

## Spacer

### PPF-S

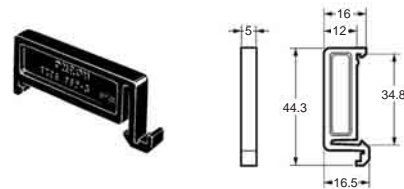

## Current Transformer (Order Separately)

### E54-CT1

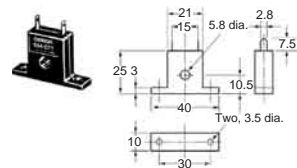

### E54-CT3

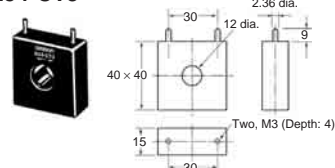

## E54-CT3 Accessories

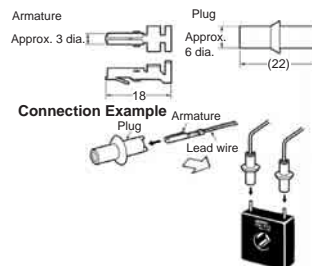

## Mounting Track (for DIN Track Mounting - Order Separately)

### PPF-100N

### PPF-50N

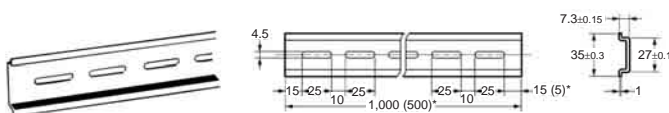

\* Indicates dimensions for the PPF-50N.

## Setting Display Unit E5ZN-SDL

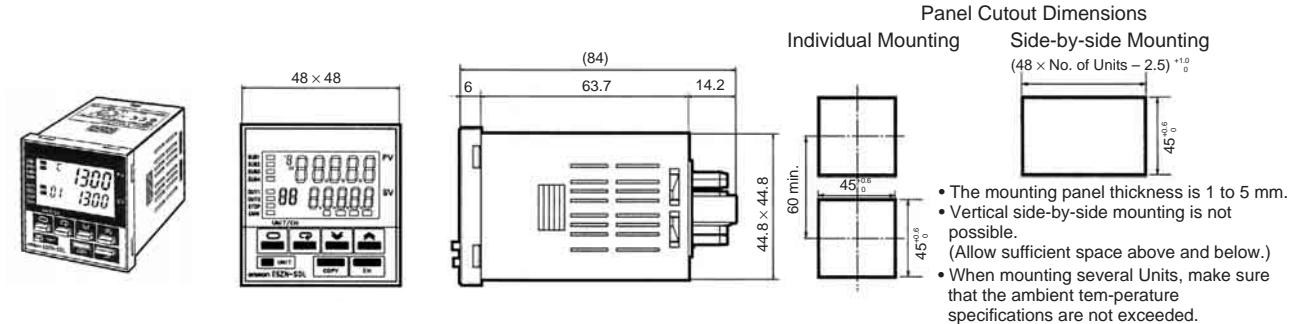

## E5ZN-SDL Wiring Sockets Front-connecting Sockets

### P2F-11 (Standard Model)

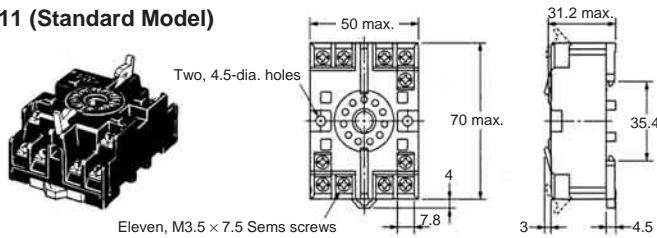

### Terminal Arrangement/ Internal Connections

(TOP VIEW)

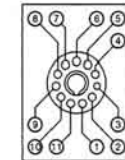

### Mounting Hole Cutout Dimensions

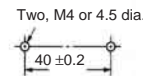

### P2F-11-E (with Finger Protection)

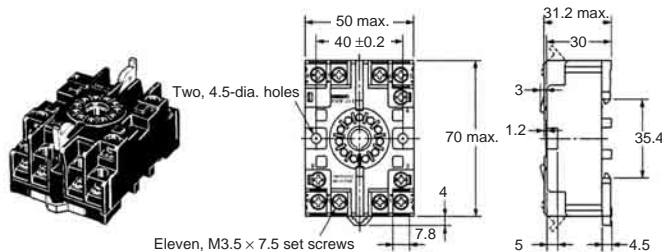

**Note:** DIN track mounting is also possible.

## Back-connecting Sockets

### P3GA-11 (Standard Model)

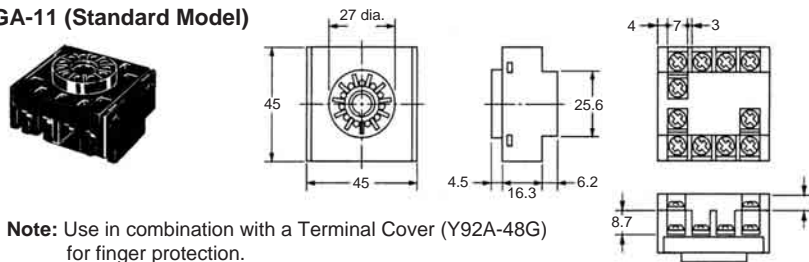

### Terminal Arrangement/ Internal Connections

(BOTTOM VIEW)

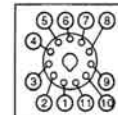

## Terminal Cover

### Y92A-48G

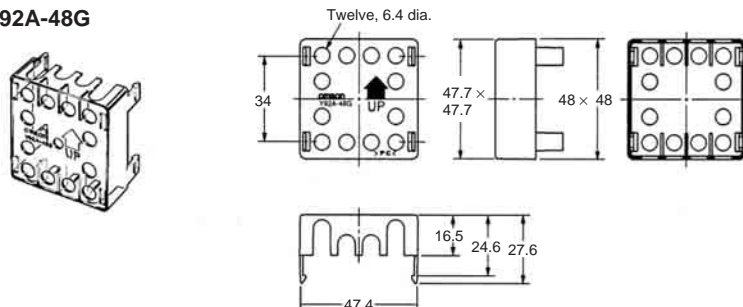



# Installation

## ■ Connection Diagrams

- Voltage output (control output) is not electrically isolated from internal circuitry. Therefore, when using grounded thermocouples, do not ground control output terminals. (Doing so may result in temperature measurement errors due to unwanted current paths.)
- There is basic insulation between the power supply inputs and outputs for this product. If reinforced insulation is required, connect the input and output terminals to equipment without any exposed charge-carrying parts, or to equipment with basic insulation sufficient for the maximum operating voltage of the power supply and the inputs and outputs.

### Using with the E5ZN-SCT24S-500

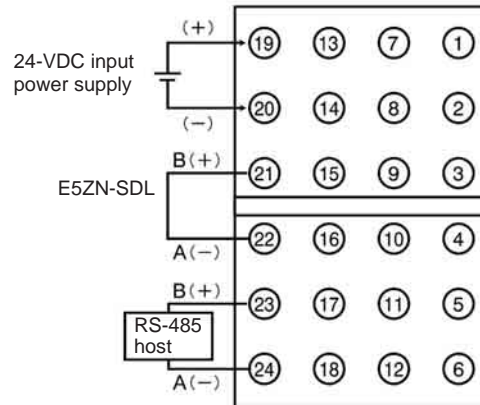

Wiring for terminals 1 to 18 is the same as for the E5ZN-SCT18S-500. See below.

### Using with the E5ZN-SCT18S-500

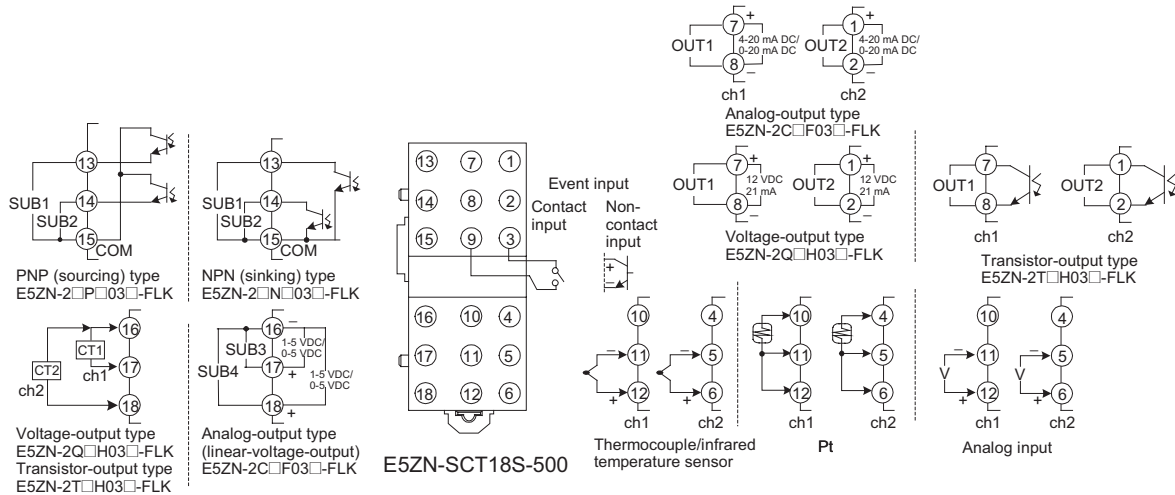

### E5ZN-SDL

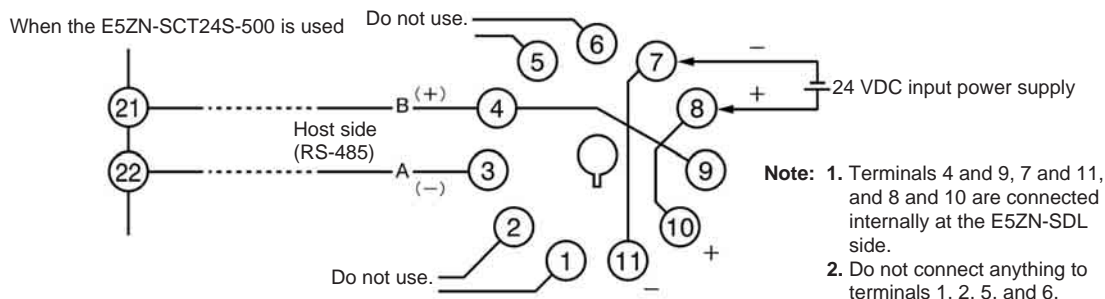

**Note:** Purchase either a P2CF-11 or a P3GA-11 Socket separately. (Refer to page 8.)

# Operation

## E5ZN-SDL Setting Data

The setting data that can be set from the E5ZN-SDL Setting Display Unit is shown below. Depending on the protection settings and other factors, some settings may not be displayed. A password is required to move to the advanced function setting level.

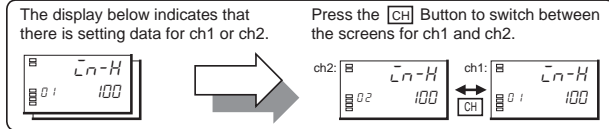

**P**: This symbol indicates setting data that is displayed only for models with pulse output. ("Models with voltage output" is used here to indicate models with voltage output or transistor output.)

**A**: This symbol indicates setting data that is displayed only for models with analog output.

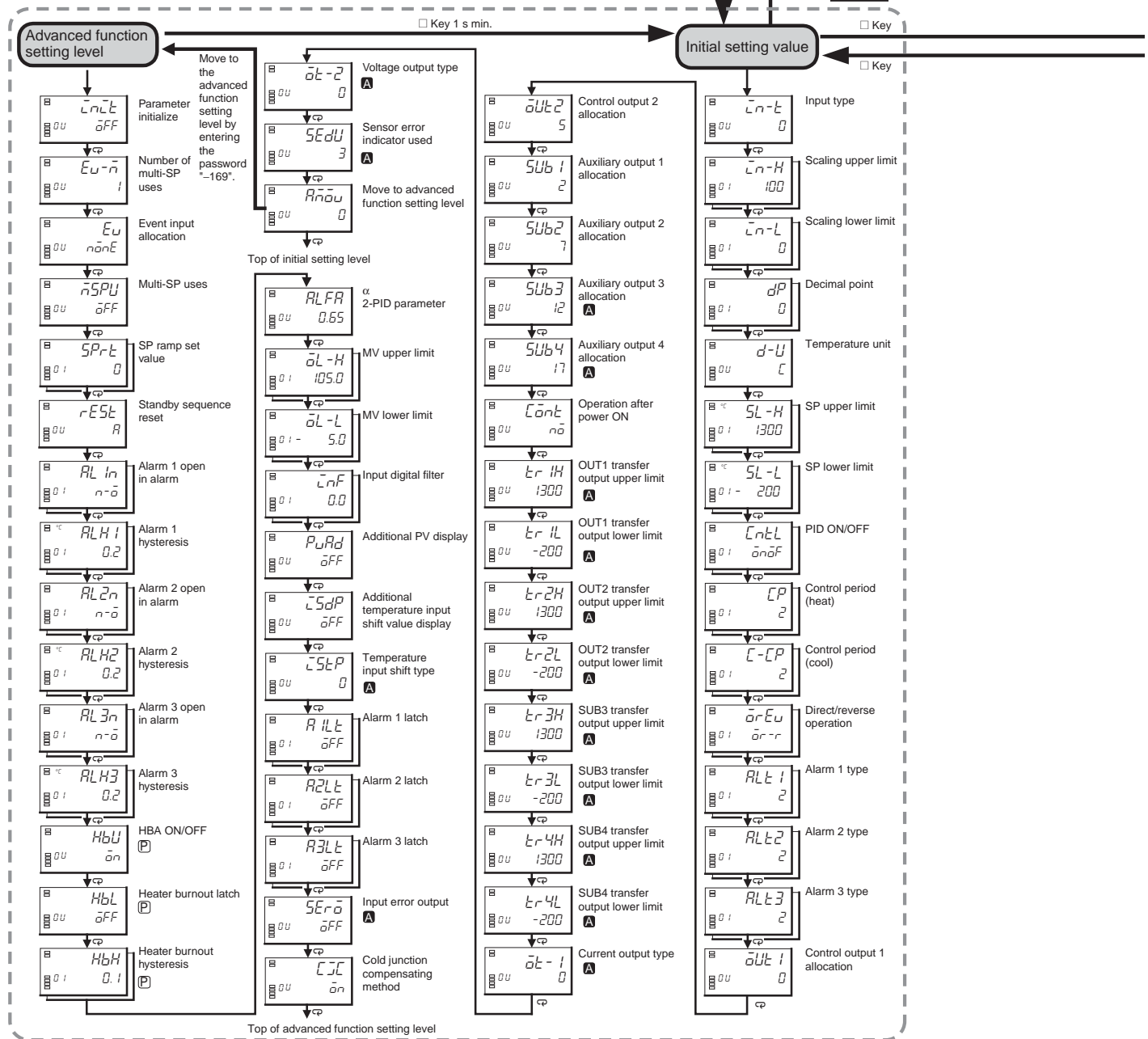

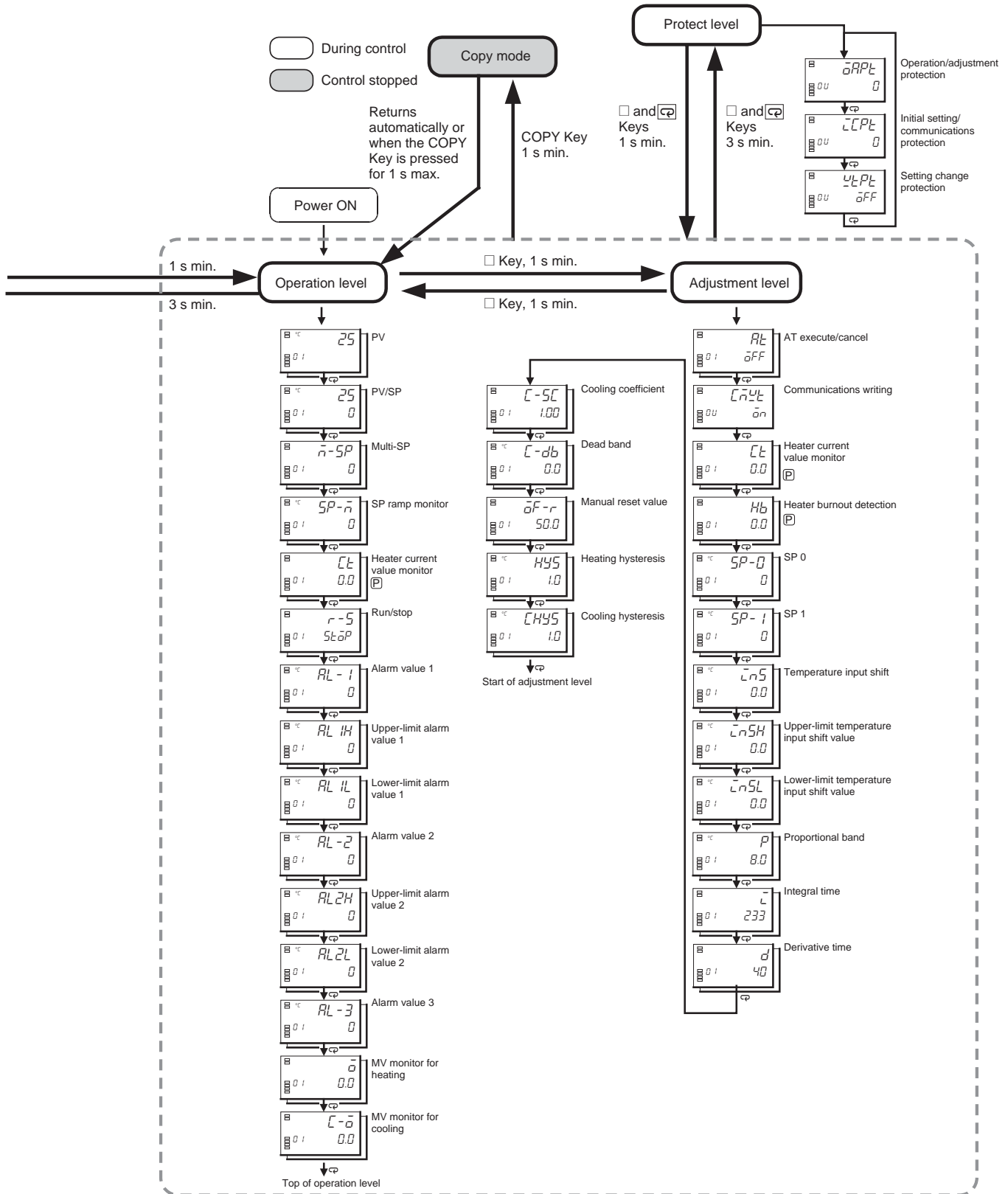

## Examples of Functions

### Using as a Temperature Input Signal Converter

#### Transfer Output Types

- The ten types of data shown below can be allocated for transfer output using the control output 1 allocation, control output 2 allocation, auxiliary output 3 allocation, and auxiliary output 4 allocation (initial setting level).
- Transfer output is supported by analog output models only.

ch1	ch2
Transfer output for ch1 set point	Transfer output for ch2 set point
Transfer output for ch1 ramp set point	Transfer output for ch2 ramp set point
Transfer output for ch1 process value	Transfer output for ch2 process value
Transfer output for ch1 heating control MV	Transfer output for ch2 heating control MV
Transfer output for ch1 cooling control MV	Transfer output for ch2 cooling control MV

**Note:** Control outputs 1 and 2 use current output and auxiliary outputs 3 and 4 use linear voltage output.

#### Transfer Output Scaling

- The range set by the transfer output upper limit and transfer output lower limit (initial setting level) can be scaled to the output range for the transfer output (4 to 20 mA DC or 0 to 20 mA DC for control outputs 1 and 2, and to 1 to 5 VDC or 0 to 5 VDC for auxiliary outputs 3 and 4).
- The scale can be expanded by setting a small range between the transfer output upper and lower limits. Reverse scaling can be performed by setting the transfer output upper limit to a value smaller than the transfer output lower limit. The following figure shows a scaling example where the heating control MV transfer output is scaled to 1 to 5 VDC.

#### Example: Scaling to 1 to 5 VDC

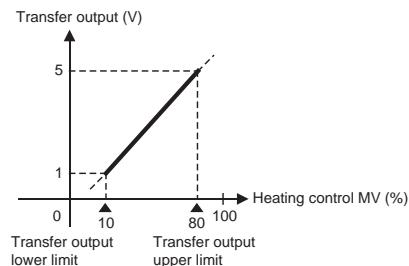

#### Example 2: Displaying the ch2 Process Values on an External Meter Using Transfer Output

Temperature Controller: E5ZN-2C□F03P-FLK (current output, platinum resistance thermometer input)  
 Meter: K3MA-J 24 VAC/VDC (Process Meter)

#### Temperature Controller Settings:

Sensor input type (initial setting level): 2 (platinum resistance thermometer, 0.0°C to 100.0°C)  
 Control output allocation 2 (initial setting level): 17 (process value transfer output for ch2)  
 OUT2 transfer output upper limit (initial setting level): 100.0 (°C)  
 OUT2 transfer output lower limit (initial setting level): 0 (°C)  
 Current output type (initial setting level): 0 (4 to 20 mA DC)

#### Meter Setting Example:

Inputs for 4 to 20 mA DC are scaled to 0.0 to 100.0°C.  
 Input type (initial setting level:  $\overline{c}n-t$ ): 4 to 20 mA DC (4-20)  
 Scaling input value 1 (initial setting level:  $\overline{c}n.P.1$ ): 4 mA (4.00)  
 Scaling display value 1 (initial setting level:  $dSP.1$ ): 0 (00000)  
 Scaling input value 2 (initial setting level:  $\overline{c}n.P.2$ ): 20 mA (20.00)  
 Scaling display value 2 (initial setting level:  $dSP.2$ ): 100 (01000)  
 Decimal point (initial setting level:  $dP$ ): One decimal place (0000.0)

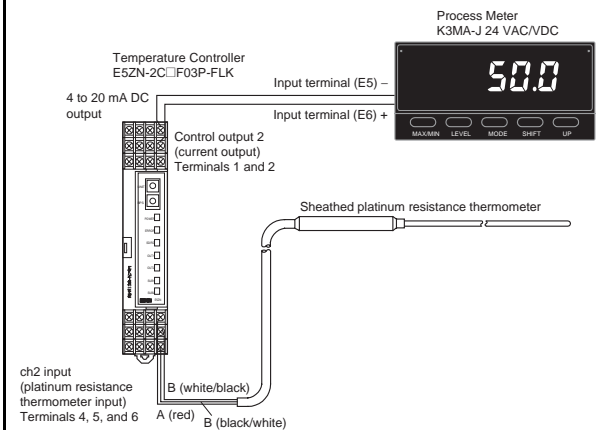

## Reading Temperatures for Multiple E5ZN Units

With conventional models, if the present temperature is read from multiple Temperature Controllers using host communications, there are time differences in the process temperatures read from each Temperature Controller, making it difficult to obtain concurrent data.

With the E5ZN, the PV hold function can be used to ensure that the data is concurrent to within 500 ms.

#### PV Hold

The PV hold function temporarily stores the present temperature for that moment as the PV hold value, when the "PV hold" operation command sent by host communications is received. (See fig. 1.)

Fig. 1

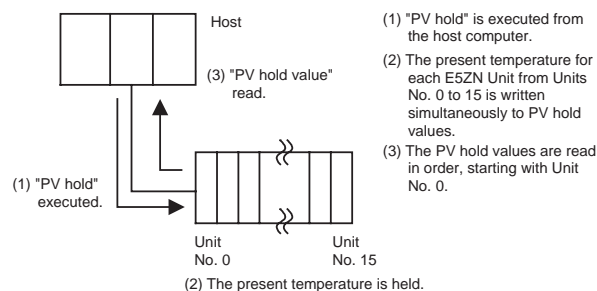

- Note:**
- PV hold values are overwritten every time the "PV hold" operation command is executed. Once the PV hold values have been read for channels that require simultaneous reading of present temperatures, execute the next "PV hold" operation command.
  - The "PV hold" operation command cannot be executed and the "PV hold value" cannot be read from the E5ZN-SDL Setting Display Unit.
  - When the power is turned OFF, the PV hold values change to 0.

# Precautions

## ■ General Precautions

The user must operate the product according to the performance specifications described in the operation manual.  
 Before using the product under conditions that are not described in the manual or applying the product to nuclear control systems, railroad systems, aviation systems, vehicles, combustion systems, medical equipment, amusement machines, safety equipment, and other systems, machines, and equipment that may have a serious influence on lives and property if used improperly, consult your OMRON representative.  
 Make sure that the ratings and performance characteristics of the product are sufficient for the systems, machines, and equipment, and be sure to provide the systems, machines, and equipment with double safety mechanisms.

## ■ Safety Precautions

### Definition of Precautionary Information

 **WARNING**  
 The above symbol indicates a situation that may result in injury or property damage.

### Warnings

 **WARNING**  
 Do not allow metal fragments or lead wire scraps to fall inside this product.  
 These may cause electric shock, fire, or malfunction.

 **WARNING**  
 Do not use the product in locations subject to flammable or explosive gases. Doing so may result in explosion.

 **WARNING**  
 Do not touch any of the terminals while the power is ON. Doing so may result in electric shock.

 **WARNING**  
 Provide at least one power-interruption switch to ensure that the power is OFF before wiring. Not doing so may result in electric shock.

 **WARNING**  
 To maintain safety in the event of a product malfunction, always take appropriate safety measures, such as installing an alarm on a separate line to prevent excessive temperature rises. If a malfunction prevents proper control, a major accident may result.

 **WARNING**  
 Do not attempt to disassemble, repair, or modify the product. Any attempt to do so may result in malfunction, fire, or electric shock.

 **WARNING**  
 Tighten screws to the specified torques given below.  
 Loose screws may result in burning or malfunction.  
 E5ZN-SCT□S-500: 0.40 to 0.56 N·m  
 E5ZN-SDL: 0.74 to 0.90 N·m

 **WARNING**  
 Set all settings according to the control target of the product.  
 If the settings are not appropriate for the control target, the product may operate in an unexpected manner, resulting in damage to the product or accidents.

## ■ Application and Operating Environment Precautions

- Observe the following points to ensure safe operation.
1. Use and store the product within the specified temperature and humidity ranges. Cool the product (e.g., using fans) where necessary.
  2. Do not touch the electronic components or pattern of the PCB. Hold the product by the case.
  3. To ensure proper heat dissipation, leave a space around the product. Do not block the product's ventilating holes.
  4. Use at the rated power supply voltage with the rated load.
  5. Be sure to connect terminals with the correct polarity.
  6. Perform wiring using crimp terminals of the specified size. (E5ZN-SCT□S-500: M3.0, width 5.8 mm max.; E5ZN-SDL: M3.5, width 7.2 mm max.)
  7. Be sure to use wires satisfying the following specifications for connection using bare wires.  
 Power supply terminals: AWG 22 to 14  
 Other terminals: AWG 28 to 16  
 (Length of exposed part: 6 to 8 mm)
  8. Do not connect anything to unused terminals.
  9. Ensure that the rated voltage is reached within 2 seconds of turning power ON.
  10. Allow 30 seconds' warm-up time.
  11. Install the product as far away as possible from devices that generate strong, high-frequency noise and devices that generate surges.
  12. Keep wiring separate from high-voltage power lines or power lines carrying large currents. Do not wire in parallel with or together with power lines.
  13. Install switches or circuit-breakers so that the user can turn the power OFF immediately, and indicate these accordingly.
  14. Do not use the product in the following locations:
    - Locations subject to dust or corrosive gases (in particular, sulfide gas and ammonia gas)
    - Locations subject to freezing or condensation
    - Locations exposed to direct sunlight
    - Locations subject to vibrations or shocks
    - Locations subject to exposure to water or oil
    - Locations subject to heat radiated directly from heating equipment
    - Locations subject to intense temperature changes
  15. When the Terminal Unit is separated from the Temperature Controller, under no circumstances touch the electrical components or apply shock to the Temperature Controller.
  16. Do not use solvents to clean the product. Use commercial alcohol.
  17. After wiring is completed remove the dust-protection label to allow proper heat dissipation.
  18. When mounting the Temperature Controller to the Terminal Unit, make sure that the hook on the side of the Temperature Controller facing the Terminal Unit is inserted properly.
  19. Install the DIN track vertically.

## ■ Correct Use

### Service Life

- Use within the following temperature and humidity ranges:
- Temperature: -10 to 55°C (with no icing or condensation)
  - Humidity: 25% to 85%

If the product is installed inside a control panel, the temperature around the product (and not the temperature around the control panel) must be kept below 55°C.

With electronic devices like the E5ZN, the service life will depend not only on the number of switching operations performed by the relay but also on the service life of the internal electronic components. The service life of these components depends on the ambient temperature; it will be shorter if the ambient temperature is high, and longer if the ambient temperature is low. For this reason, the service life of the product can be lengthened by keeping the inside of the E5ZN at a low temperature.

If several Units are mounted side-by-side or are arranged vertically, the heat generated may cause the internal temperature of the Units to rise, reducing service life. To prevent this, take steps to ensure that the Units are cooled, such as installing fans.

Ensure, however, that the terminals are not also cooled, otherwise correct temperature measurement will not be possible.

### Measurement Accuracy

When extending the lead wires for thermocouples, use a compensating conductor appropriate for the type of thermocouple used.

When extending the lead wires for platinum resistance thermometers, use lead wires with a low resistance, and make the resistance in the 3 lead wires equal.

Mount the E5ZN horizontally.

If significant errors occur, check that input compensation has been set correctly.

### Waterproofing

The enclosure ratings are given below. Parts for which the enclosure rating is not clearly indicated, and parts with IP□0 ratings (where □ is not 0) do not have waterproof specifications.

- Temperature Controller: IP00
- Terminal Unit: IP00

**Note:** Refer to the following manual for precautionary information and other information necessary to use the E5ZN: E5ZN Temperature Controller Operation Manual (Cat. No. H113).

### Mounting and Dismounting

- To mount using a mounting track, first hook part A (see below) onto the track and then push down on part B.

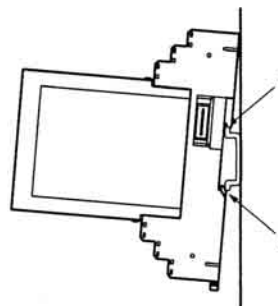

- To dismount, insert a flat-bladed screwdriver into part C, pull the hook down, and then lift the bottom part of the E5ZN upwards.

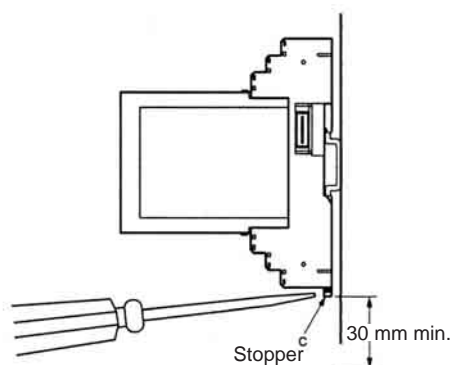

- Mount the E5ZN at least 30 mm away from other devices to ensure easy mounting and dismounting.

## Warranty and Limitations of Liability

---

### ■ WARRANTY

OMRON's exclusive warranty is that the products are free from defects in materials and workmanship for a period of one year (or other period if specified) from date of sale by OMRON.

OMRON MAKES NO WARRANTY OR REPRESENTATION, EXPRESS OR IMPLIED, REGARDING NON-INFRINGEMENT, MERCHANTABILITY, OR FITNESS FOR PARTICULAR PURPOSE OF THE PRODUCTS. ANY BUYER OR USER ACKNOWLEDGES THAT THE BUYER OR USER ALONE HAS DETERMINED THAT THE PRODUCTS WILL SUITABLY MEET THE REQUIREMENTS OF THEIR INTENDED USE. OMRON DISCLAIMS ALL OTHER WARRANTIES, EXPRESS OR IMPLIED.

### ■ LIMITATIONS OF LIABILITY

OMRON SHALL NOT BE RESPONSIBLE FOR SPECIAL, INDIRECT, OR CONSEQUENTIAL DAMAGES, LOSS OF PROFITS, OR COMMERCIAL LOSS IN ANY WAY CONNECTED WITH THE PRODUCTS, WHETHER SUCH CLAIM IS BASED ON CONTRACT, WARRANTY, NEGLIGENCE, OR STRICT LIABILITY.

In no event shall the responsibility of OMRON for any act exceed the individual price of the product on which liability is asserted.

IN NO EVENT SHALL OMRON BE RESPONSIBLE FOR WARRANTY, REPAIR, OR OTHER CLAIMS REGARDING THE PRODUCTS UNLESS OMRON'S ANALYSIS CONFIRMS THAT THE PRODUCTS WERE PROPERLY HANDLED, STORED, INSTALLED, AND MAINTAINED AND NOT SUBJECT TO CONTAMINATION, ABUSE, MISUSE, OR INAPPROPRIATE MODIFICATION OR REPAIR.

## Application Considerations

---

### ■ SUITABILITY FOR USE

OMRON shall not be responsible for conformity with any standards, codes, or regulations that apply to the combination of products in the customer's application or use of the products.

At the customer's request, OMRON will provide applicable third party certification documents identifying ratings and limitations of use that apply to the products. This information by itself is not sufficient for a complete determination of the suitability of the products in combination with the end product, machine, system, or other application or use.

The following are some examples of applications for which particular attention must be given. This is not intended to be an exhaustive list of all possible uses of the products, nor is it intended to imply that the uses listed may be suitable for the products.

- Outdoor use, uses involving potential chemical contamination or electrical interference, or conditions or uses not described in this catalog.
- Nuclear energy control systems, combustion systems, railroad systems, aviation systems, medical equipment, amusement machines, vehicles, safety equipment, and installations subject to separate industry or government regulations.
- Systems, machines, and equipment that could present a risk to life or property.

Please know and observe all prohibitions of use applicable to the products.

NEVER USE THE PRODUCTS FOR AN APPLICATION INVOLVING SERIOUS RISK TO LIFE OR PROPERTY WITHOUT ENSURING THAT THE SYSTEM AS A WHOLE HAS BEEN DESIGNED TO ADDRESS THE RISKS, AND THAT THE OMRON PRODUCTS ARE PROPERLY RATED AND INSTALLED FOR THE INTENDED USE WITHIN THE OVERALL EQUIPMENT OR SYSTEM.

ALL DIMENSIONS SHOWN ARE IN MILLIMETERS.

To convert millimeters into inches, multiply by 0.03937. To convert grams into ounces, multiply by 0.03527.

Cat. No. H116-E1-02A In the interest of product improvement, specifications are subject to change without notice.

---

**OMRON Corporation**

**Industrial Automation Company**

**Measuring and Control Division**

Shiokoji Horikawa, Shimogyo-ku,

Kyoto, 600-8530 Japan

Tel: (81)75-344-7080/Fax: (81)75-344-7189

Printed in Japan  
0303-1M (1200) (A)