

### Compact Background Suppression With Metal Housing

- Stable detection regardless of material color or size of sensing object: 2% or less black/white error at 20 cm
- Adjustable setting distance: 2% or less differential travel at 20 cm
- Sensing unaffected by dirty lens
- 6-turn potentiometer sensitivity adjustment (clutched) with indicator
- IP67 water resistant housing
- NPN/PNP output (switch selectable)
- Conforms to relevant EN/IEC standards



### Ordering Information

Part Number	E3S-CL1	E3S-CL2
Method of operation	Distance-settable	
Operating mode	Light-ON/Dark-ON (switch selectable)	
Detecting distance	0.5 to 20 cm (0.20 to 7.87 inch)	0.5 to 50 cm (0.20 to 19.7 inch)

### Application Examples

E3S-CL1	E3S-CL2
<p><b>Detecting Milk Cartons</b></p> <p>Stable detection is not affected by stainless steel background or carton colors and patterns.</p> <p>Stainless steel background</p> <p>E3S-CL1</p>	<p><b>Detecting Food Products on Conveyors</b></p> <p>Overhead detection is possible.</p> <p>E3S-CL1</p>
	<p><b>Detecting Tires on a Conveyor Line</b></p> <p>Stably detecting black objects such as tires.</p> <p>E3S-CL2</p>

## Specifications

Part number		E3S-CL1	E3S-CL2
Method of detection		Distance-settable	
Supply voltage		10 to 30 VDC (10% max. permissible ripple peak-to-peak)	
Current consumption		35 mA max.	
Setting distance		Adjustable 4 to 20 cm (1.57 to 7.87 inch) with 20 X 20 cm (7.87 to 7.87 inch) 90% reflectance white paper	Adjustable 5 to 50 cm (1.97 to 19.69 inch) with 20 X 20 cm (7.87 to 7.87 inch) 90% reflectance white paper
Detecting distance		0.5 to 20 cm (0.20 to 7.87 inch)	0.5 to 50 cm (0.20 to 19.69 inch)
Non-detecting range	At max. setting distance	white paper: 0 to 2.7 mm (0.11 inch) black paper: 0 to 23.7 mm (0.93 inch)	white paper: 0 to 0.7 mm (0.03 inch) black paper: 0 to 6.2 mm (0.24 inch)
	At min. setting distance	white paper: 0 to 1.4 mm (0.06 inch) >33.7 mm (1.33 inch) black paper: 0 to 11.4 mm (0.45 inch) >32.7 mm (1.29 inch)	white paper: 0 to 0.4 mm (0.02 inch) >36 mm (1.42 inch) black paper: 0 to 2.6 mm (0.10 inch) >33 mm (1.30 inch)
Sensitivity		Adjustable: 6-turn (clutched) potentiometer with indicator	
Spot size at:	20 cm detecting distance	≤18 mm (0.71 inch) diameter	≤24 mm (0.94 inch) diameter
	5 cm detecting distance	≤9 mm (0.35 inch) diameter	≤10 mm (0.39 inch) diameter
Light source		Red LED (700 nm)	Infrared LED (860 nm)
Hysteresis		2% max. of detection distance	10% max. of detection distance (5% for white paper)
Black/white detecting error		2% max. at 20 cm (7.87 inch) detecting distance for standard white and 5% reflectance black paper	10% max. of detection distance for standard white and 5% reflectance black paper
Repeat accuracy		Perpendicular to optical axis: 0.5 mm (0.02 inch) max. Parallel to optical Z axis: 1 mm (0.039 inch) max.	Perpendicular to optical axis: 0.5 mm (0.02 inch) max. Parallel to optical Z axis: 10 mm (0.39 inch) max.
Operation mode		Light-ON/Dark-ON operation (switch selectable)	
Mutual interference protection		Provided	
Control output	Type	NPN or PNP (switch selectable) open collector current output	
	Max. load	100 mA max.	
	Residual voltage	NPN output: 1.2 V max.; PNP output: 2.0 V max.	
Response time	ON	1 ms. max.	
	OFF	1 ms. max.	
Circuit protection		Load short-circuit protection, reversed polarity protection	
Vibration resistance	Destruction	10 to 55 Hz, 1.5 mm (0.06 inch) double amplitude, or 300 m/s <sup>2</sup> (approx. 30 G) for 2 hours each in X, Y, and Z directions	
Shock resistance	Destruction	500 m/s <sup>2</sup> (approx. 50 G) 3 times each in X, Y, and Z directions	
Indicators		Light incident (orange), stability indicator (green)	
Materials	Lens	Acrylic	
	Case	Zinc die-cast	
	Operating panel	Sulfonated polyether	
	Mounting bracket	Stainless steel	
Mounting		Side mounting with 2 through holes, bracket and hardware included	
Connections	Prewired	Three conductor cable, 2 m (6.56 ft) length	
Weight		120 g (4.23 oz)	
Enclosure ratings	UL	-	
	IEC	IP67	
	NEMA	6P	
Ambient temperature	Operating	-25° C to 55° C (-13° F to 131° F)	

# Engineering Data

## DETECTION DISTANCE VS. OBJECT SIZE

### E3S-CL1

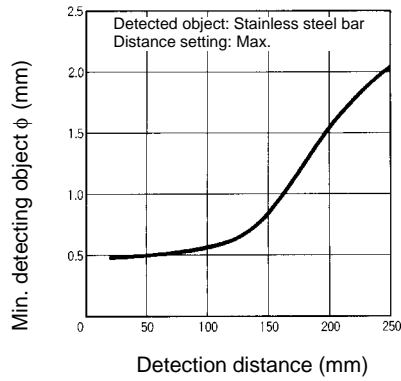

### E3S-CL2

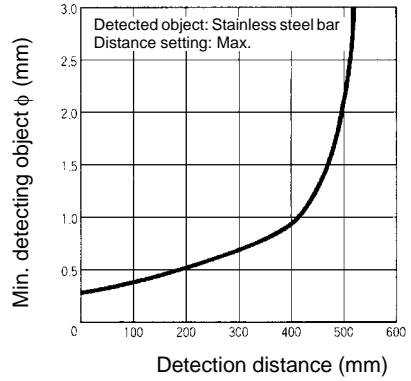

## SPOT DIAMETER VS. DETECTION DISTANCE

### E3S-CL1

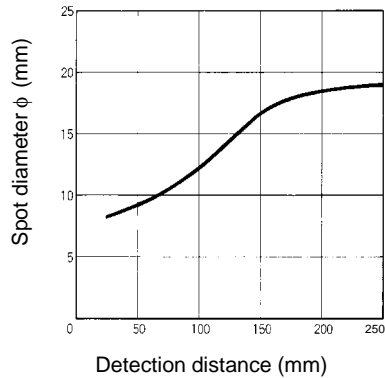

### E3S-CL2

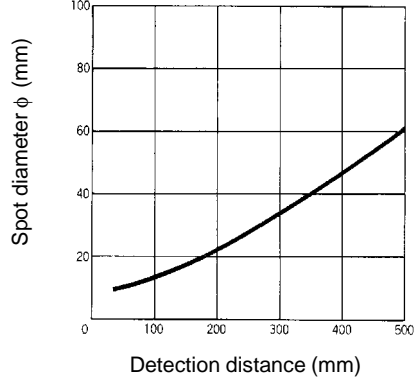

## OPERATING RANGE

### E3S-CL1

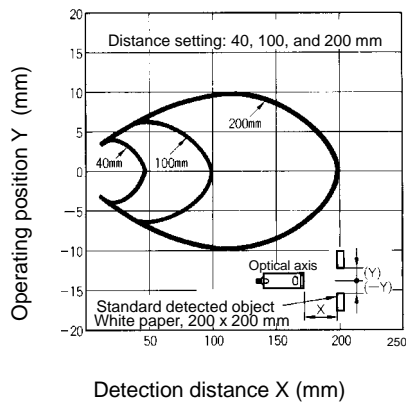

### E3S-CL2

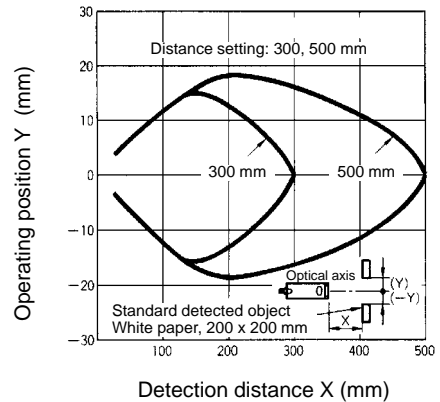

**DETECTION DISTANCE VS. OBJECT SIZE**

**E3S-CL1**

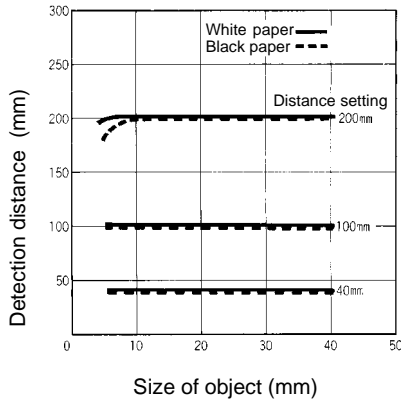

**E3S-CL2**

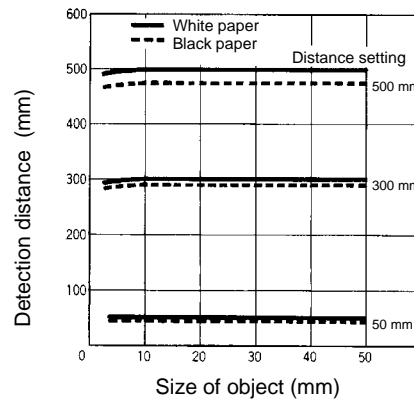

**ANGLE CHARACTERISTIC**

**Vertical Detection**

**E3S-CL1**

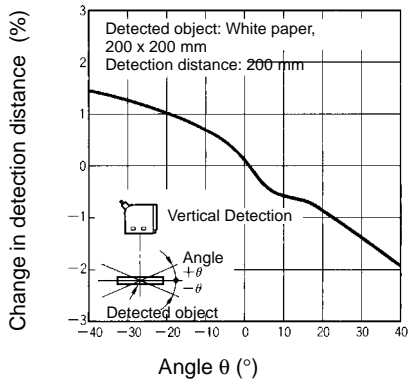

**Horizontal Detection**

**E3S-CL1**

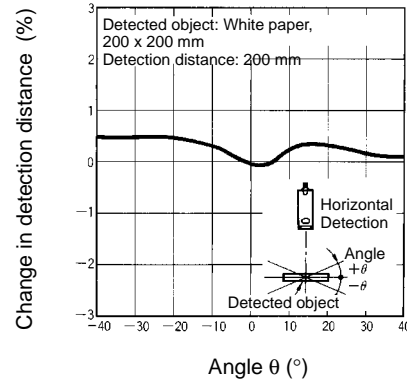

**Vertical Detection**

**E3S-CL2**

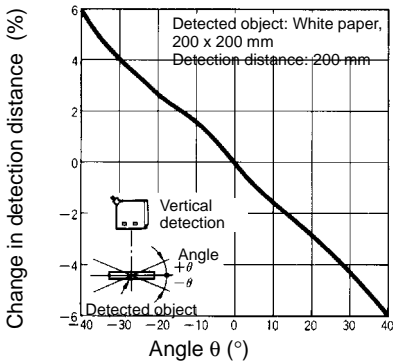

**Horizontal Detection**

**E3S-CL2**

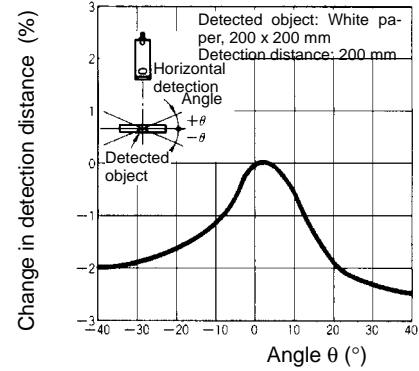

■ DETECTION DISTANCE VS. MATERIAL

E3S-CL1

(Setting Distance Set to 200 mm using White Paper)

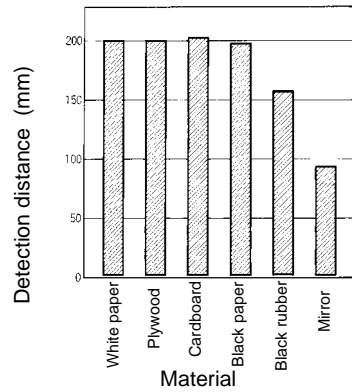

(Setting Distance Set to 100 mm using White Paper)

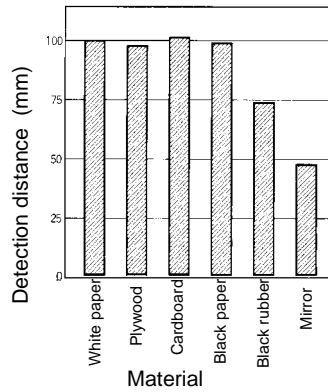

(Setting Distance Set to 40 mm using White Paper)

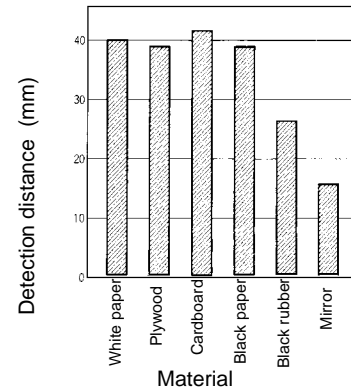

E3S-CL2

(Setting Distance Set to 500 mm using White Paper)

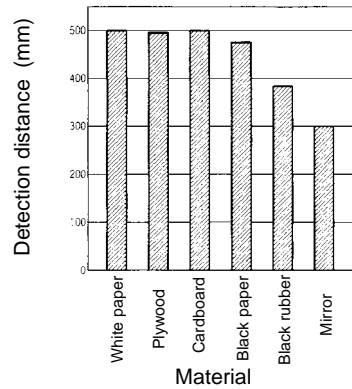

(Setting Distance Set to 300 mm using White Paper)

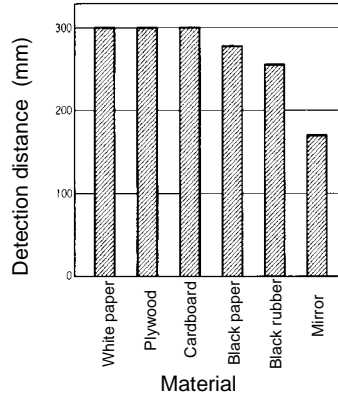

(Setting Distance Set to 50 mm using White Paper)

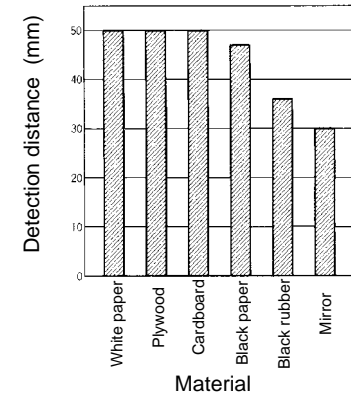

Nomenclature

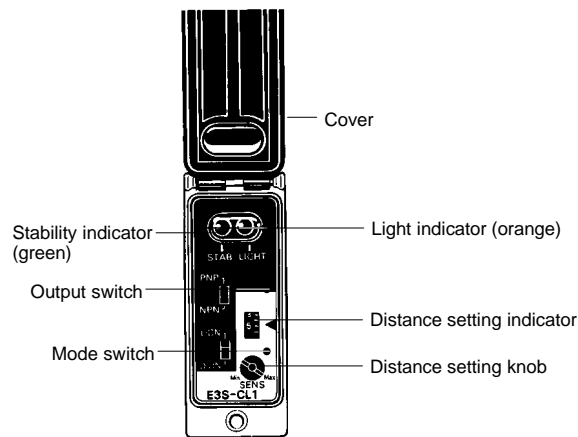

Output Switch

1. Set the switch to NPN for NPN output.
2. Set the switch to PNP for PNP output.

Mode Switch

1. Set the switch to L-ON for ON light-ON operation.
2. Set the switch to D-ON for ON dark-ON operation.

Distance Setting Knob

1. The detection distance will increase when the knob is turned clockwise (toward Max.) and will decrease when the knob is turned counterclockwise.
2. The adjustment can be turned up to 6 times clockwise or counterclockwise to set the detection distance. The number of turns will be displayed by the indicator.

# Operation

## OUTPUT CIRCUITS

Output Configuration	Mode Switch	Output Transistor	Output Circuits
NPN	Light-ON	ON when light is received.	<p>ZD : Vz = 39 V</p>
	Dark-ON	ON when light is not received.	
PNP	Light-ON	ON when light is received.	<p>ZD : Vz = 39 V</p>
	Dark-ON	ON when light is not received.	

## SENSITIVITY ADJUSTMENT

Item	Position A	Position B and C	Setting
Adjustment procedure	Place the detected object at the desired location and turn the adjustment knob clockwise until the LIGHT indicator (orange) lights. This is position A.	<p><b>Background Object</b> Remove the detected object and turn the adjustment knob clockwise until the LIGHT indicator (orange) lights. This is position B. Then turn the adjustment knob counterclockwise until the LIGHT indicator (orange) goes out. This is position C.</p> <p><b>No Background Object</b> The maximum adjustment setting is used as position C.</p>	Set the adjustment to halfway between A and C. Confirm that the STAB indicator (green) remains lit both with the detected object present and not present. If the STAB indicator does not remain lit, reconsider the detection method to enable stable operation.
Detecting condition			---
Status of distance setting knob and distance setting indicator			
Indicators	<p>OFF  STABILITY (green)    ON  LIGHT (orange)</p>	<p>OFF  STABILITY (green)    OFF  LIGHT (orange)</p>	<p>ON  STABILITY (green)    OFF  LIGHT (orange)</p>

Note: The sensor must be set to within the rated detection range for application (see diagrams on next page).  
 Background interference can be a problem if the distance is set near the maximum value (5 to 6 on the scale). Factory settings are as follows:  
 E3S-CL1: 20 cm (on white paper)  
 E3S-CL2: 50 cm (on white paper)

■ SET DISTANCE INDICATOR SCALE VS. DETECTION DISTANCE CHARACTERISTIC (TYPICAL)

E3S-CL1

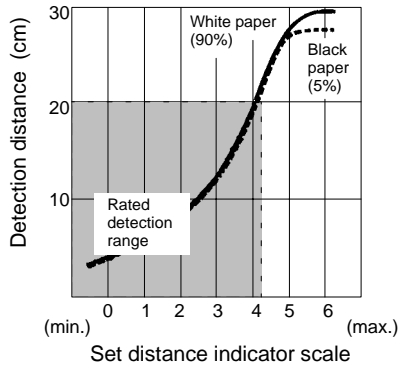

E3S-CL2

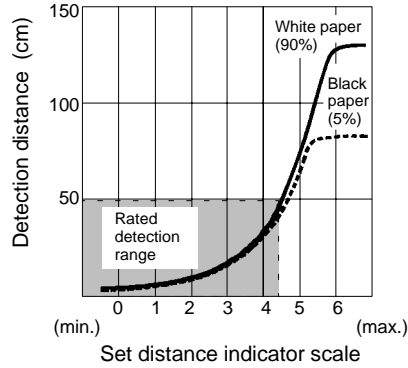

Note: Reflection rates are given in parentheses.

Dimensions

Unit: mm (inch)

E3S-CL1  
E3S-CL2

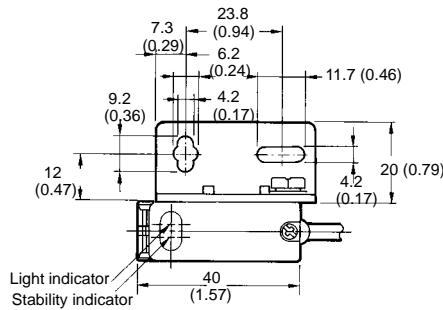
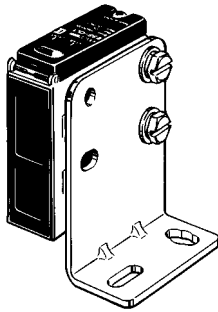

Mounting Holes

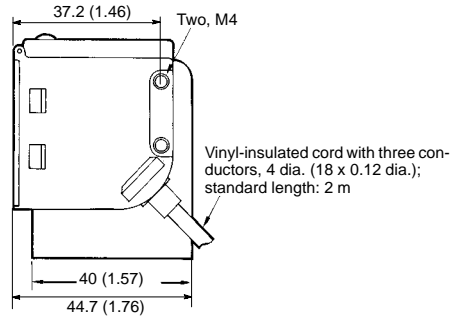
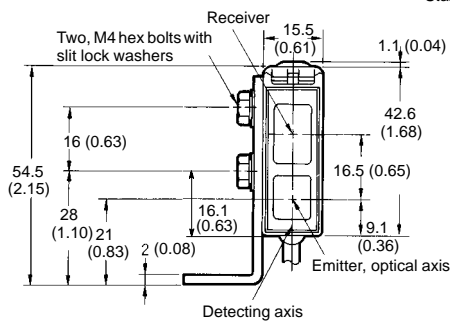
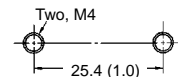

Note: The output switch, mode switch, and distance setting knob can be accessed by removing the cover.

# Precautions

## ■ CONNECTION

To avoid malfunction or damage, do not wire the input/output lines within the same conduit with power lines or high voltage lines.

The cord connected to the Sensor can be extended up to 100 m provided that the diameter of each wire of the cord is 0.3 mm<sup>2</sup> minimum.

## ■ POWER SUPPLY

If a standard switching regulator is used as a power supply, the frame ground (FG) terminal and the ground (G) terminal must be grounded, otherwise the Sensor may malfunction due to the switching noise of the power supply.

## ■ OIL AND CHEMICAL RESISTANCE (E3S-CL2)

Oil	Kinematic Viscosity (mm <sup>2</sup> /s (cst)) at 40°C	PH
Lubricating oil	2.02	---
Water insoluble machining oil	10 min. and less than 50	---
	Less than 10	
Water soluble machining oil	---	7 to 9.5
		7 to 9.9
		7 to 9.2
		7 to 9.8

Note: 1. The E3S-CL2 maintained a minimum insulation resistance of 100 MΩ after the E3S-CL2 was dipped in all the above oils at a temperature of 50°C for 240 hours.

2. When using the E3S-CL2 in a place where an oil other than the ones listed above is sprayed on the E3S-CL2, refer to the above kinematic viscosity and pH values. The location may be suitable for the E3S-CL2 if the kinematic viscosity and pH values of the oil are close to the above kinematic viscosity and pH values, but make sure that the oil does not contain any additive that may have a negative influence on the E3S-CL2.

## ■ CABLE

The E3S-CL2 uses an oil-resistant cord to ensure oil resistivity. Do not allow the cable to be repeatedly bent during application. Do not allow the cable to be bent to a radius of less than 25 mm.

## ■ STARTUP OPERATION

A maximum of 100 ms is required from the time power is turned on until the E3S-CL is able to detect objects. If power is supplied to the loads and the E3S-CL from different sources, turn on power to the E3S-CL first.

## ■ WATER RESISTANCE

To ensure the water resistance of the E3S-CL, tighten the screws of the operation panel cover to a torque of 2.5 to 5.0 kgf • cm (0.25 N • m to 0.49 N • m).

## ■ MALFUNCTIONING

If an inverter motor or servomotor is used with the E3S-CL, the frame ground (FG) terminal and the ground (G) terminal must be grounded, otherwise the Sensor may malfunction.

## ■ MOUNTING

### Mounting Direction

Mount the Sensor so that the detection face runs parallel to the surface of the object being detected and not at an angle (see below).

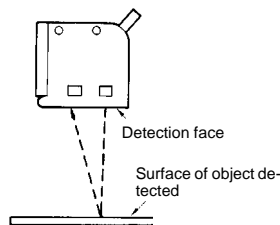

If detecting a shiny object, mount the Sensor so that the detection face is at an angle of between 5° and 10° of the surface of the object being detected. Check to be sure that there is no interference from the background (see below).

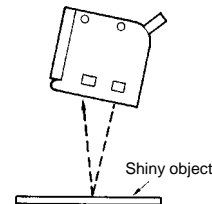



If stable operation is not possible near a mirror surface, mount the Sensor at an angle as shown below, and separate the Sensor as far as possible from the mirror surface.

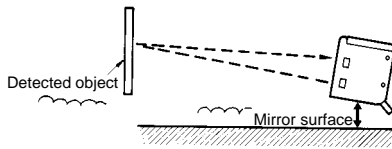

Mount the Sensor so that it is not aligned with the direction of movement of the detected object, as shown below.

Mount the Sensor so that it is not aligned with extreme changes in color or materials, as shown below.

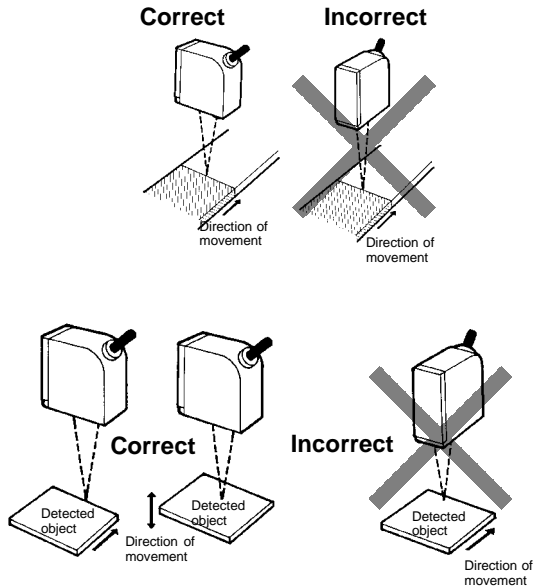

Mount the Sensor so that sunlight, fluorescent light, incandescent light, or other strong sources of light do not enter the directional angle of the Sensor.

### Precautions

When mounting the Sensor, do not hit the Sensor with a hammer, or any other object. This will cause the Sensor to lose its watertightness.

Use M4 screws to mount the Sensor.

The tightening torque of each screw must be 12 kgf • m (1.18 N • m) maximum.

### Direct Mounting

Mount the Sensor as shown in the following illustration.

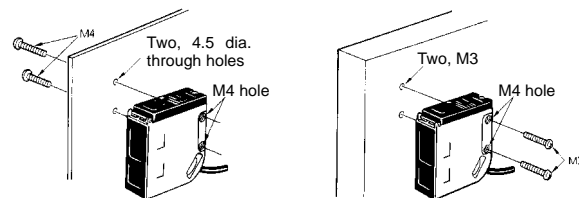

### ! WARNING

The E3S-CL is not a safety component for ensuring the safety of people which is defined in EC directive (91/368/EEC) and covered by separate European standards or by any other regulations or standards.

**NOTE: DIMENSIONS SHOWN ARE IN MILLIMETERS. To convert millimeters to inches divide by 25.4.**

# OMRON®

Omron Europe B.V. EMA-ISD, tel:+31 23 5681390, fax:+31 23 5681397, <http://www.eu.omron.com/ema>